

# 20D Series Tube Fittings

20,000 psig (1379 bar)



Fittings

Tubing

Quick Couplings

Line Filters

Valves

Sour Service Products

Subsea Valves

Part Number Crossover Charts

# Contents

## Nuts - N



A-13

## Front Ferrules - FF



A-13

## Rear Ferrules - RF



A-13

## Nut-Ferrule Sets - NFS



A-13

## Ferrule Sets - FRS



A-13

## Plugs - DTP



A-14

## Caps - DTC

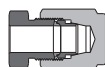

A-14

## Unions - DU



A-14

## Reducing Unions - DU



A-15

## Bulkhead Unions - DBU

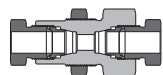

A-15

## Male Connectors - DCM

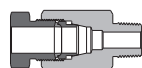

A-16

## Female Connectors - DCF

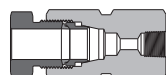

A-17

## Union Elbows - DLU

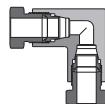

A-17

## Union Reducing Elbows - DLU

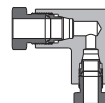

A-17

## Male Elbows - DLM

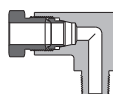

A-18

## Union Tees - DT

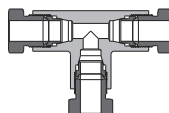

A-18

## Male Branch Tees - DT

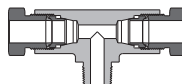

A-19

## Union Crosses - DX

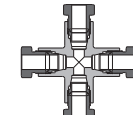

A-19

## Reducers - DR



A-20

## Port Connectors - DP



A-20

## Adapters - DAM

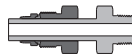

A-20

## Installation Instructions

A-110

## Connection Information

A-02

## Ordering Number Description

A-21

## Features

- ⦿ Working pressure up to 20,000 psig (1379 bar)
- ⦿ Easy and quick connection to T15A, T20D and T20M series tubing, tubing sizes available in 1/8", 1/4", 3/8", 1/2", 9/16", 3/4" and 1"
- ⦿ High tensile 316 stainless steel material
- ⦿ Nut threads coated with molybdenum disulfide-based lubricant to minimize the friction
- ⦿ Long tube-support area to improve vibration resistance and line loads
- ⦿ Every fitting marked with size, material and trace ID
- ⦿ EC-79 type approval for 70 MPa hydrogen system application

## Standard Materials of Construction

Component	Material
<i>Body, ferrules</i>	316 stainless steel
Nut	316 stainless steel

*Wetted components listed in italics.*

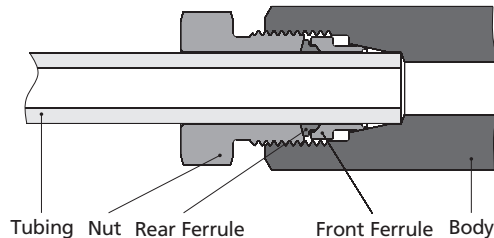

## Working Pressure

- ⦿ Working pressure is determined by the lowest working pressure of the ends.

### Tube Ends

The working pressure of tube ends at ambient temperature is determined by the working pressure of the tubing used.

For details, please refer to "Working Pressure at Ambient Temperature" on B-06 and B-08.

**CAUTION: 20D Series Tube Fittings are applicable for use with T20M Series Tubing. But the match is not the best choice. 20D Series Tube Fittings are best match with T20D Series Tubing, which is recommended.**

### Male SAE O-Ring Ends

Working pressure of male SAE O-ring end connections listed in this catalog is 10,000 psig (690 bar).

### NPT Ends

NPT Size in.	Working Pressure psig (bar)
1/8	15,000 (1,034)
1/4	
3/8	
1/2	
3/4	10,000 (690)
1	

### T20D Series Tubing

Working pressures are calculated in accordance with ASME B31.3 Chapter IX High Pressure Piping.

Tube O.D. in.	Wall Thickness in.	Working Pressure psig (bar)
1/4	0.065	20,000 (1,379)
3/8	0.083	
1/2	0.109	
3/4	0.165	
1	0.172	15,000 (1,034)

## Working Temperature

Connection Type	Working Temperature Range, °F (°C)
Tube Ends	-325 to 800 (-198 to 427)
Male SAE O-Ring Ends	0 to 400 (-17.8 to 204) <sup>①</sup>
NPT Ends	-325 to 400 (-198 to 204) <sup>②③</sup>

① The ends are supplied with a fluorocarbon FKM O-ring as standard, other materials of O-rings available.

② Always use proper thread sealants on tapered pipe threads.

③ The data are based on the working temperature range of the thread sealants. For the working temperature above 400°F (204°C), please contact FITOK Group or our authorized distributors.

Fittings
Tubing
Quick Couplings
Line Filters
Valves
Sour Service Products
Subsea Valves
Part Number Crossover Charts

## Ordering Information and Dimensions

Dimensions are for reference only and are subject to change.

### Nuts

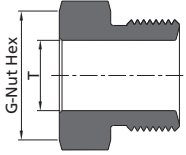

Tube		
T - Tube O.D. in.	Ordering Number	Dimensions, in. (mm)
		G
1/8	SS-N-DFF2	0.37 (9.5)
1/4	SS-N-DFF4	0.63 (15.9)
3/8	SS-N-DFF6	0.75 (19.1)
1/2	SS-N-DFF8	0.94 (23.8)
9/16	SS-N-DFF9	1.06 (27.0)
3/4	SS-N-DFF12	1.38 (34.9)
1	SS-N-DFF16	1.88 (47.6)

### Front Ferrules

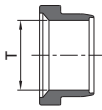

Tube	
T - Tube O.D. in.	Ordering Number
1/8	SS-FF-DFF2
1/4	SS-FF-DFF4
3/8	SS-FF-DFF6
1/2	SS-FF-DFF8
9/16	SS-FF-DFF9
3/4	SS-FF-DFF12
1	SS-FF-DFF16

### Rear Ferrules



Tube	
T - Tube O.D. in.	Ordering Number
1/8	SS-RF-DFF2
1/4	SS-RF-DFF4
3/8	SS-RF-DFF6
1/2	SS-RF-DFF8
9/16	SS-RF-DFF9
3/4	SS-RF-DFF12
1	SS-RF-DFF16

### Nut-Ferrule Sets



Figure above shows the nut-ferrule set with an arbor. One arbor holds 1 nut-ferrule set. The nut-ferrule set contains 1 nut, 1 rear ferrule and 1 front ferrule.

Tube	
T - Tube O.D. in.	Ordering Number
1/8	SS-NFS-DFF2
1/4	SS-NFS-DFF4
3/8	SS-NFS-DFF6
1/2	SS-NFS-DFF8
9/16	SS-NFS-DFF9
3/4	SS-NFS-DFF12
1	SS-NFS-DFF16

### Ferrule Sets



Figure above shows the nut-ferrule sets with an arbor. One arbor holds 5 ferrule sets. The ferrule set contains 1 rear ferrule and 1 front ferrule. Please order ferrule sets in multiples of 5.

Tube	
T - Tube O.D. in.	Ordering Number
1/8	SS-FRS-DFF2
1/4	SS-FRS-DFF4
3/8	SS-FRS-DFF6
1/2	SS-FRS-DFF8
9/16	SS-FRS-DFF9
3/4	SS-FRS-DFF12
1	SS-FRS-DFF16

**Plugs**<sup>①</sup>

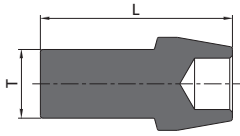

Tube		
T - Tube O.D. in.	Ordering Number	Dimensions, in. (mm)
		L
1/8	SS-DTP-DFF2	0.95 (24.2)
1/4	SS-DTP-DFF4	1.20 (30.4)
3/8	SS-DTP-DFF6	1.19 (30.2)
1/2	SS-DTP-DFF8	1.36 (34.6)
9/16	SS-DTP-DFF9	1.73 (44.0)
3/4	SS-DTP-DFF12	2.30 (58.3)
1	SS-DTP-DFF16	2.64 (67.0)

① When using plug, ferrules are not required.

**Caps**

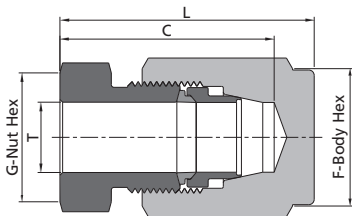

Tube					
T - Tube O.D. in.	Ordering Number	Dimensions, in. (mm)			
		L	C	F	G
1/8	SS-DTC-DFF2	1.22 (31.1)	1.07 (27.2)	0.50 (12.7)	0.37 (9.5)
1/4	SS-DTC-DFF4	1.70 (43.1)	1.38 (35.2)	0.63 (15.9)	0.63 (15.9)
3/8	SS-DTC-DFF6	1.76 (44.8)	1.42 (36.1)	0.75 (19.1)	0.75 (19.1)
1/2	SS-DTC-DFF8	1.85 (47.0)	1.56 (39.6)	1.00 (25.4)	0.94 (23.8)
9/16	SS-DTC-DFF9	2.46 (62.6)	1.93 (49.0)	1.13 (28.6)	1.06 (27.0)
3/4	SS-DTC-DFF12	3.22 (81.9)	2.49 (63.3)	1.50 (38.1)	1.38 (34.9)
1	SS-DTC-DFF16	4.06 (103.2)	3.24 (82.3)	2.00 (50.8)	1.88 (47.6)

**Unions**

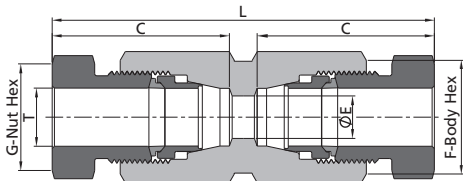

Tube						
T - Tube O.D. in.	Ordering Number	Dimensions, in. (mm)				
		L	C	E	F	G
1/8	SS-DU-DFF2	2.45 (62.2)	1.07 (27.2)	0.09 (2.4)	0.50 (12.7)	0.37 (9.5)
1/4	SS-DU-DFF4	3.00 (76.2)	1.38 (35.2)	0.19 (4.8)	0.63 (15.9)	0.63 (15.9)
3/8	SS-DU-DFF6	3.07 (77.9)	1.42 (36.1)	0.25 (6.4)	0.75 (19.1)	0.75 (19.1)
1/2	SS-DU-DFF8	3.36 (85.4)	1.56 (39.6)	0.37 (9.5)	1.00 (25.4)	0.94 (23.8)
9/16	SS-DU-DFF9	4.11 (104.4)	1.93 (49.0)	0.41 (10.4)	1.13 (28.6)	1.06 (27.0)
3/4	SS-DU-DFF12	5.38 (136.7)	2.49 (63.3)	0.56 (14.2)	1.50 (38.1)	1.38 (34.9)
1	SS-DU-DFF16	7.06 (179.3)	3.24 (82.3)	0.69 (17.5)	2.00 (50.8)	1.88 (47.6)

Fittings
Tubing
Quick Couplings
Line Filters
Valves
Sour Service Products
Subsea Valves
Part Number Crossover Charts

Reducing Unions

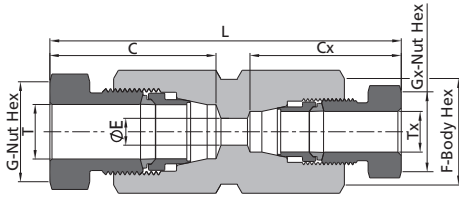

Tube			Dimensions, in. (mm)							
T - Tube O.D. in.	Tx - Tube O.D. in.	Ordering Number	L	C	Cx	E	F	G	Gx	
1/4	1/8	SS-DU-DFF4-DFF2	2.73 (69.4)	1.39 (35.2)	1.07 (27.2)	0.09 (2.4)	0.63 (15.9)	0.63 (15.9)	0.37 (9.5)	
3/8	1/8	SS-DU-DFF6-DFF2	2.77 (70.3)	1.42 (36.1)	1.07 (27.2)	0.09 (2.4)	0.75 (19.1)	0.75 (19.1)	0.37 (9.5)	
3/8	1/4	SS-DU-DFF6-DFF4	3.06 (77.6)	1.42 (36.1)	1.39 (35.2)	0.19 (4.8)	0.75 (19.1)	0.75 (19.1)	0.63 (15.9)	
1/2	1/4	SS-DU-DFF8-DFF4	3.35 (85.1)	1.56 (39.6)	1.39 (35.2)	0.19 (4.8)	1.00 (25.4)	0.94 (23.8)	0.63 (15.9)	
1/2	3/8	SS-DU-DFF8-DFF6	3.32 (84.3)	1.56 (39.6)	1.42 (36.1)	0.25 (6.4)	1.00 (25.4)	0.94 (23.8)	0.75 (19.1)	
9/16	1/2	SS-DU-DFF9-DFF8	4.04 (102.5)	1.93 (49.0)	1.56 (39.6)	0.37 (9.5)	1.13 (28.6)	1.06 (27.0)	0.94 (23.8)	
3/4	1/2	SS-DU-DFF12-DFF8	4.73 (120.2)	2.49 (63.3)	1.56 (39.6)	0.37 (9.5)	1.50 (38.1)	1.38 (34.9)	0.94 (23.8)	
1	1/2	SS-DU-DFF16-DFF8	5.35 (135.9)	3.24 (82.3)	1.56 (39.6)	0.37 (9.5)	2.00 (50.8)	1.88 (47.6)	0.94 (23.8)	

Bulkhead Unions

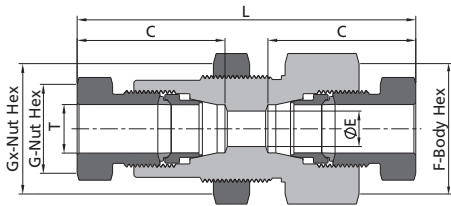

Tube		Dimensions, in. (mm)							
T - Tube O.D. in.	Ordering Number	L	C	E	F	G	Gx	Panel Hole Size	Maximum Panel Thickness
1/8	SS-DBU-DFF2	2.95 (75.0)	1.07 (27.2)	0.09 (2.4)	0.75 (19.1)	0.37 (9.5)	0.81 (20.6)	0.69 (17.5)	0.38 (9.7)
1/4	SS-DBU-DFF4	3.27 (83.1)	1.38 (35.2)	0.19 (4.8)	1.00 (25.4)	0.63 (15.9)	1.06 (27.0)	0.94 (23.9)	0.38 (9.7)
3/8	SS-DBU-DFF6	3.21 (81.6)	1.42 (36.1)	0.25 (6.4)	1.00 (25.4)	0.75 (19.1)	1.06 (27.0)	0.94 (23.9)	0.38 (9.7)
1/2	SS-DBU-DFF8	3.93 (99.8)	1.56 (39.6)	0.37 (9.5)	1.38 (34.9)	0.94 (23.8)	1.38 (34.9)	1.13 (28.6)	0.38 (9.7)
9/16	SS-DBU-DFF9	4.64 (117.8)	1.93 (49.0)	0.41 (10.4)	1.63 (41.3)	1.06 (27.0)	1.63 (41.3)	1.33 (33.7)	0.38 (9.7)
3/4	SS-DBU-DFF12	5.82 (147.9)	2.49 (63.3)	0.56 (14.2)	1.87 (47.6)	1.38 (34.9)	1.87 (47.6)	1.64 (41.7)	0.38 (9.7)
1	SS-DBU-DFF16	7.45 (189.3)	3.24 (82.3)	0.69 (17.5)	2.50 (63.5)	1.88 (47.6)	2.50 (63.5)	2.27 (57.6)	0.38 (9.7)

Male Connectors

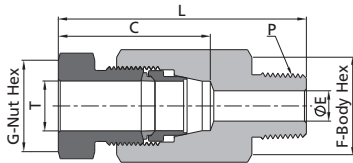

Tube			NPT Thread				
T - Tube O.D. in.	P - NPT Size in.	Ordering Number	Dimensions, in. (mm)				
			L	C	E	F	G
1/8	1/8	SS-DCM-DFF2-NS2	1.60 (40.6)	1.07 (27.2)	0.09 (2.4)	0.50 (12.7)	0.37 (9.5)
1/8	1/4	SS-DCM-DFF2-NS4	1.72 (43.8)	1.07 (27.2)	0.09 (2.4)	0.56 (14.3)	0.37 (9.5)
1/8	3/8	SS-DCM-DFF2-NS6	1.72 (43.8)	1.07 (27.2)	0.09 (2.4)	0.69 (17.5)	0.37 (9.5)
1/4	1/8	SS-DCM-DFF4-NS2	1.95 (49.5)	1.39 (35.2)	0.19 (4.8)	0.63 (15.9)	0.63 (15.9)
1/4	1/4	SS-DCM-DFF4-NS4	2.08 (52.8)	1.39 (35.2)	0.19 (4.8)	0.63 (15.9)	0.63 (15.9)
1/4	3/8	SS-DCM-DFF4-NS6	2.08 (52.8)	1.39 (35.2)	0.19 (4.8)	0.69 (17.5)	0.63 (15.9)
1/4	1/2	SS-DCM-DFF4-NS8	2.32 (59.0)	1.39 (35.2)	0.19 (4.8)	0.87 (22.2)	0.63 (15.9)
3/8	1/4	SS-DCM-DFF6-NS4	2.17 (55.1)	1.42 (36.1)	0.25 (6.4)	0.75 (19.1)	0.75 (19.1)
3/8	3/8	SS-DCM-DFF6-NS6	2.17 (55.1)	1.42 (36.1)	0.25 (6.4)	0.75 (19.1)	0.75 (19.1)
3/8	1/2	SS-DCM-DFF6-NS8	2.30 (58.3)	1.42 (36.1)	0.25 (6.4)	0.87 (22.2)	0.75 (19.1)
1/2	1/4	SS-DCM-DFF8-NS4	2.53 (64.3)	1.56 (39.6)	0.25 (6.4)	1.00 (25.4)	0.94 (23.8)
1/2	3/8	SS-DCM-DFF8-NS6	2.53 (64.3)	1.56 (39.6)	0.31 (7.9)	1.00 (25.4)	0.94 (23.8)
1/2	1/2	SS-DCM-DFF8-NS8	2.65 (67.4)	1.56 (39.6)	0.37 (9.5)	1.00 (25.4)	0.94 (23.8)
1/2	3/4	SS-DCM-DFF8-NS12	2.53 (64.3)	1.56 (39.6)	0.37 (9.5)	1.06 (27.0)	0.94 (23.8)
9/16	1/4	SS-DCM-DFF9-NS4	3.03 (77.0)	1.93 (49.0)	0.25 (6.4)	1.13 (28.6)	1.06 (27.0)
9/16	1/2	SS-DCM-DFF9-NS8	3.11 (79.1)	1.93 (49.0)	0.38 (9.6)	1.13 (28.6)	1.06 (27.0)
3/4	1/2	SS-DCM-DFF12-NS8	3.74 (95.1)	2.49 (63.3)	0.38 (9.6)	1.50 (38.1)	1.38 (34.9)
3/4	3/4	SS-DCM-DFF12-NS12	3.74 (95.1)	2.49 (63.3)	0.56 (14.2)	1.50 (38.1)	1.38 (34.9)
3/4	1	SS-DCM-DFF12-NS16	3.83 (97.4)	2.49 (63.3)	0.56 (14.2)	1.50 (38.1)	1.38 (34.9)
1	1/2	SS-DCM-DFF16-NS8	4.46 (113.2)	3.24 (82.3)	0.38 (9.6)	2.00 (50.8)	1.88 (47.6)
1	3/4	SS-DCM-DFF16-NS12	4.46 (113.2)	3.24 (82.3)	0.58 (14.8)	2.00 (50.8)	1.88 (47.6)
1	1	SS-DCM-DFF16-NS16	4.65 (118.1)	3.24 (82.3)	0.69 (17.5)	2.00 (50.8)	1.88 (47.6)

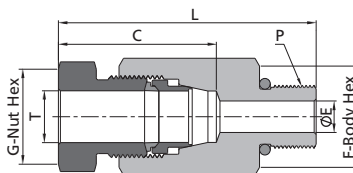

Tube			Male SAE O-Ring				
T - Tube O.D. in.	P - SAE/MS Thread Size	Ordering Number	Dimensions, in. (mm)				
			L	C	E	F	G
1/8	7/16-20	SS-DCM-DFF2-SH7	1.60 (40.6)	1.07 (27.2)	0.09 (2.4)	0.56 (14.3)	0.37 (9.5)
1/8	9/16-18	SS-DCM-DFF2-SH9	1.66 (42.2)	1.07 (27.2)	0.09 (2.4)	0.69 (17.5)	0.37 (9.5)
1/4	7/16-20	SS-DCM-DFF4-SH7	2.04 (51.7)	1.39 (35.2)	0.18 (4.5)	0.63 (15.9)	0.63 (15.9)
1/4	9/16-18	SS-DCM-DFF4-SH9	2.07 (52.7)	1.39 (35.2)	0.19 (4.8)	0.69 (17.5)	0.63 (15.9)
3/8	7/16-20	SS-DCM-DFF6-SH7	2.09 (53.0)	1.42 (36.1)	0.18 (4.5)	0.75 (19.1)	0.75 (19.1)
3/8	9/16-18	SS-DCM-DFF6-SH9	2.13 (54.0)	1.42 (36.1)	0.25 (6.4)	0.75 (19.1)	0.75 (19.1)
1/2	7/16-20	SS-DCM-DFF8-SH7	2.49 (63.3)	1.56 (39.6)	0.18 (4.5)	1.00 (25.4)	0.94 (23.8)
1/2	9/16-18	SS-DCM-DFF8-SH9	2.49 (63.3)	1.56 (39.6)	0.30 (7.5)	1.00 (25.4)	0.94 (23.8)

Fittings
Tubing
Quick Couplings
Line Filters
Valves
Sour Service Products
Subsea Valves
Part Number Crossover Charts

Female Connectors

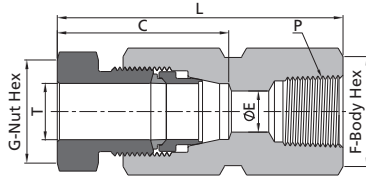

Tube			NPT Thread				
T - Tube O.D. in.	P - NPT Size in.	Ordering Number	Dimensions, in. (mm)				
			L	C	E	F	G
1/8	1/8	SS-DCF-DFF2-FNS2	1.97 (50.1)	1.07 (27.2)	0.09 (2.4)	0.63 (15.9)	0.37 (9.5)
1/8	1/4	SS-DCF-DFF2-FNS4	2.01 (53.3)	1.07 (27.2)	0.09 (2.4)	0.94 (23.8)	0.37 (9.5)
1/4	1/4	SS-DCF-DFF4-FNS4	2.33 (59.1)	1.38 (35.2)	0.19 (4.8)	0.94 (23.8)	0.63 (15.9)
3/8	1/4	SS-DCF-DFF6-FNS4	2.29 (58.1)	1.42 (36.1)	0.25 (6.4)	0.94 (23.8)	0.75 (19.1)
1/2	1/4	SS-DCF-DFF8-FNS4	2.78 (70.6)	1.56 (39.6)	0.37 (9.5)	1.00 (25.4)	0.94 (23.8)
1/2	1/2	SS-DCF-DFF8-FNS8	3.03 (77.0)	1.56 (39.6)	0.37 (9.5)	1.38 (34.9)	0.94 (23.8)
3/4	1/2	SS-DCF-DFF12-FNS8	3.85 (97.8)	2.49 (63.3)	0.56 (14.2)	1.50 (38.1)	1.38 (34.9)
1	1	SS-DCF-DFF16-FNS16	4.75 (120.7)	3.24 (82.3)	0.69 (17.5)	2.00 (50.8)	1.88 (47.6)

Union Elbows

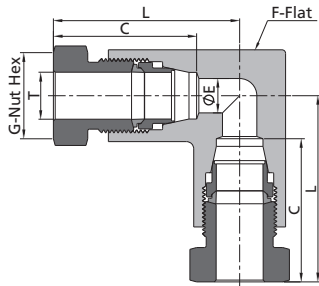

Tube		Dimensions, in. (mm)				
T - Tube O.D. in.	Ordering Number	L	C	E	F	G
1/8	SS-DLU-DFF2	1.29 (32.7)	1.07 (27.2)	0.09 (2.4)	0.63 (15.9)	0.37 (9.5)
1/4	SS-DLU-DFF4	1.70 (43.1)	1.38 (35.2)	0.19 (4.8)	0.63 (15.9)	0.63 (15.9)
3/8	SS-DLU-DFF6	1.67 (42.4)	1.42 (36.1)	0.25 (6.4)	0.75 (19.1)	0.75 (19.1)
1/2	SS-DLU-DFF8	2.03 (51.6)	1.56 (39.6)	0.37 (9.5)	1.00 (25.4)	0.94 (23.8)
9/16	SS-DLU-DFF9	2.43 (61.8)	1.93 (49.0)	0.41 (10.4)	1.38 (34.9)	1.06 (27.0)
3/4	SS-DLU-DFF12	3.11 (79.1)	2.49 (63.3)	0.56 (14.2)	1.50 (38.1)	1.38 (34.9)
1	SS-DLU-DFF16	4.14 (105.2)	3.24 (82.3)	0.69 (17.5)	2.25 (57.2)	1.88 (47.6)

Union Reducing Elbows

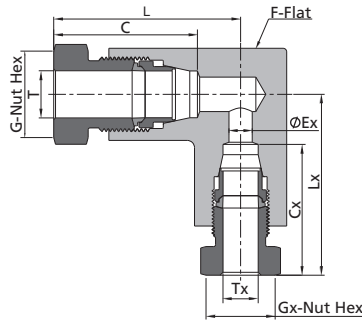

Tube			Dimensions, in. (mm)							
T - Tube O.D. in.	Tx - Tube O.D. in.	Ordering Number	L	Lx	C	Cx	Ex	F	G	Gx
1/4	1/8	SS-DLU-DFF4-DFF2	1.70 (43.1)	1.37 (34.7)	1.38 (35.2)	1.07 (27.2)	0.09 (2.4)	0.63 (15.9)	0.63 (15.9)	0.37 (9.5)
3/8	1/8	SS-DLU-DFF6-DFF2	1.67 (42.4)	1.33 (33.7)	1.42 (36.1)	1.07 (27.2)	0.09 (2.4)	0.75 (19.1)	0.75 (19.1)	0.37 (9.5)
3/8	1/4	SS-DLU-DFF6-DFF4	1.67 (42.4)	1.70 (43.1)	1.42 (36.1)	1.38 (35.2)	0.19 (4.8)	0.75 (19.1)	0.75 (19.1)	0.63 (15.9)
1/2	1/4	SS-DLU-DFF8-DFF4	2.03 (51.6)	1.95 (49.5)	1.56 (39.6)	1.38 (35.2)	0.19 (4.8)	0.94 (23.8)	1.00 (25.4)	0.63 (15.9)
1/2	3/8	SS-DLU-DFF8-DFF6	2.03 (51.6)	1.96 (49.8)	1.56 (39.6)	1.42 (36.1)	0.25 (6.4)	0.94 (23.8)	1.00 (25.4)	0.75 (19.1)
9/16	1/2	SS-DLU-DFF9-DFF8	2.43 (61.8)	2.37 (60.2)	1.93 (49.0)	1.56 (39.6)	0.37 (9.5)	1.38 (34.9)	1.06 (27.0)	0.94 (23.8)
3/4	1/2	SS-DLU-DFF12-DFF8	3.11 (79.1)	2.49 (63.3)	2.49 (63.3)	1.56 (39.6)	0.37 (9.5)	1.50 (38.1)	1.38 (34.9)	0.94 (23.8)
1	1/2	SS-DLU-DFF16-DFF8	4.14 (105.2)	2.47 (62.8)	3.24 (82.3)	1.56 (39.6)	0.37 (9.5)	2.25 (57.2)	1.88 (47.6)	0.94 (23.8)
1	9/16	SS-DLU-DFF16-DFF9	4.14 (105.2)	2.82 (71.6)	3.24 (82.3)	1.93 (49.0)	0.41 (10.4)	2.25 (57.2)	1.88 (47.6)	1.06 (27.0)
1	3/4	SS-DLU-DFF16-DFF12	4.14 (105.2)	3.45 (87.6)	3.24 (82.3)	2.49 (63.3)	0.56 (14.2)	2.25 (57.2)	1.88 (47.6)	1.38 (34.9)

Fittings

Tubing

Quick Couplings

Line Filters

Valves

Sour Service Products

Subsea Valves

Part Number Crossover Charts



**Male Elbows**

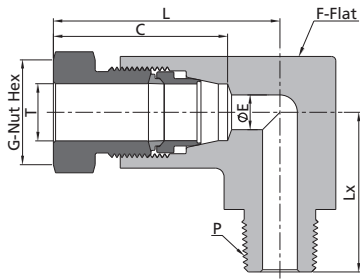

Tube			NPT Thread						
T - Tube O.D. in.	P - NPT Size in.	Ordering Number	Dimensions, in. (mm)						
			L	Lx	C	E	F	G	
1/8	1/8	SS-DLM-DFF2-NS2	1.29 (32.7)	0.79 (20.0)	1.07 (27.2)	0.09 (2.4)	0.63 (15.9)	0.37 (9.5)	
1/8	1/4	SS-DLM-DFF2-NS4	1.39 (35.3)	1.00 (25.4)	1.07 (27.2)	0.09 (2.4)	0.63 (15.9)	0.37 (9.5)	
1/8	3/8	SS-DLM-DFF2-NS6	1.47 (37.4)	1.00 (25.4)	1.07 (27.2)	0.09 (2.4)	0.75 (19.1)	0.37 (9.5)	
1/4	1/4	SS-DLM-DFF4-NS4	1.70 (43.1)	0.94 (23.8)	1.38 (35.2)	0.19 (4.8)	0.63 (15.9)	0.63 (15.9)	
1/4	3/8	SS-DLM-DFF4-NS6	1.70 (43.1)	1.00 (25.4)	1.38 (35.2)	0.19 (4.8)	0.75 (19.1)	0.63 (15.9)	
1/4	1/2	SS-DLM-DFF4-NS8	1.70 (43.1)	1.38 (34.9)	1.38 (35.2)	0.19 (4.8)	1.00 (25.4)	0.63 (15.9)	
3/8	1/4	SS-DLM-DFF6-NS4	1.67 (42.4)	1.00 (25.4)	1.42 (36.1)	0.25 (6.4)	0.75 (19.1)	0.75 (19.1)	
3/8	3/8	SS-DLM-DFF6-NS6	1.67 (42.4)	1.06 (27.0)	1.42 (36.1)	0.25 (6.4)	0.75 (19.1)	0.75 (19.1)	
3/8	1/2	SS-DLM-DFF6-NS8	1.67 (42.4)	1.38 (34.9)	1.42 (36.1)	0.25 (6.4)	1.00 (25.4)	0.75 (19.1)	
1/2	1/4	SS-DLM-DFF8-NS4	2.03 (51.6)	1.19 (30.2)	1.56 (39.6)	0.25 (6.4)	1.00 (25.4)	0.94 (23.8)	
1/2	3/8	SS-DLM-DFF8-NS6	2.03 (51.6)	1.19 (30.2)	1.56 (39.6)	0.31 (7.9)	1.00 (25.4)	0.94 (23.8)	
1/2	1/2	SS-DLM-DFF8-NS8	2.03 (51.6)	1.38 (34.9)	1.56 (39.6)	0.37 (9.5)	1.00 (25.4)	0.94 (23.8)	
9/16	1/2	SS-DLM-DFF9-NS8	2.43 (61.8)	1.56 (39.5)	1.93 (49.0)	0.38 (9.6)	1.38 (34.9)	1.06 (27.0)	
3/4	1/2	SS-DLM-DFF12-NS8	3.11 (79.1)	1.73 (44.0)	2.49 (63.3)	0.38 (9.6)	1.50 (38.1)	1.38 (34.9)	
3/4	3/4	SS-DLM-DFF12-NS12	3.11 (79.1)	1.73 (44.0)	2.49 (63.3)	0.56 (14.2)	1.50 (38.1)	1.38 (34.9)	
1	1/2	SS-DLM-DFF16-NS8	4.14 (105.2)	2.06 (52.4)	3.24 (82.3)	0.38 (9.6)	2.25 (57.2)	1.88 (47.6)	
1	3/4	SS-DLM-DFF16-NS12	4.14 (105.2)	2.06 (52.4)	3.24 (82.3)	0.58 (14.8)	2.25 (57.2)	1.88 (47.6)	
1	1	SS-DLM-DFF16-NS16	4.14 (105.2)	2.25 (57.2)	3.24 (82.3)	0.69 (17.5)	2.25 (57.2)	1.88 (47.6)	

**Union Tees**

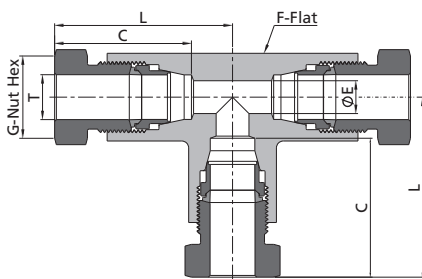

Tube		Dimensions, in. (mm)				
T - Tube O.D. in.	Ordering Number	L	C	E	F	G
1/8	SS-DT-DFF2	1.37 (34.7)	1.07 (27.2)	0.09 (2.4)	0.63 (15.9)	0.37 (9.5)
1/4	SS-DT-DFF4	1.70 (43.1)	1.38 (35.2)	0.19 (4.8)	0.63 (15.9)	0.63 (15.9)
3/8	SS-DT-DFF6	1.67 (42.4)	1.42 (36.1)	0.25 (6.4)	0.75 (19.1)	0.75 (19.1)
1/2	SS-DT-DFF8	2.03 (51.6)	1.56 (39.6)	0.37 (9.5)	1.00 (25.4)	0.94 (23.8)
9/16	SS-DT-DFF9	2.43 (61.8)	1.93 (49.0)	0.41 (10.4)	1.38 (34.9)	1.06 (27.0)
3/4	SS-DT-DFF12	3.11 (79.1)	2.49 (63.3)	0.56 (14.2)	1.50 (38.1)	1.38 (34.9)
1	SS-DT-DFF16	4.14 (105.2)	3.24 (82.3)	0.69 (17.5)	2.25 (57.2)	1.88 (47.6)

Fittings
Tubing
Quick Couplings
Line Filters
Valves
Sour Service Products
Subsea Valves
Part Number Crossover Charts

Male Branch Tees

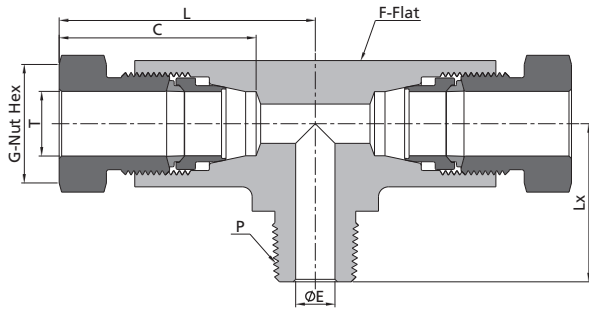

Tube			NPT Thread						
T - Tube O.D. in.	P - NPT Size in.	Ordering Number	Dimensions, in. (mm)						
			L	Lx	C	E	F	G	
1/8	1/8	SS-DT-DFF2-DFF2-NS2	1.37 (34.7)	0.79 (20.0)	1.07 (27.2)	0.09 (2.4)	0.63 (15.9)	0.37 (9.5)	
1/8	1/4	SS-DT-DFF2-DFF2-NS4	1.37 (34.7)	1.00 (25.4)	1.07 (27.2)	0.09 (2.4)	0.63 (15.9)	0.37 (9.5)	
1/4	1/8	SS-DT-DFF4-DFF4-NS2	1.70 (43.1)	0.81 (20.6)	1.38 (35.2)	0.19 (4.8)	0.63 (15.9)	0.63 (15.9)	
1/4	1/4	SS-DT-DFF4-DFF4-NS4	1.70 (43.1)	1.00 (25.4)	1.38 (35.2)	0.19 (4.8)	0.63 (15.9)	0.63 (15.9)	
3/8	1/4	SS-DT-DFF6-DFF6-NS4	1.67 (42.4)	1.06 (27.0)	1.42 (36.1)	0.25 (6.4)	0.75 (19.1)	0.75 (19.1)	
1/2	1/4	SS-DT-DFF8-DFF8-NS4	2.03 (51.6)	1.19 (30.2)	1.56 (39.6)	0.25 (6.4)	1.00 (25.4)	0.94 (23.8)	
1/2	3/8	SS-DT-DFF8-DFF8-NS6	2.03 (51.6)	1.19 (30.2)	1.56 (39.6)	0.31 (7.9)	1.00 (25.4)	0.94 (23.8)	
3/4	3/4	SS-DT-DFF12-DFF12-NS12	3.11 (79.1)	1.73 (44.0)	2.49 (63.3)	0.56 (14.2)	1.50 (38.1)	1.38 (34.9)	
1	1/2	SS-DT-DFF16-DFF16-NS8	4.14 (105.2)	2.06 (52.4)	3.24 (82.3)	0.38 (9.6)	2.25 (57.2)	1.88 (47.6)	
1	3/4	SS-DT-DFF16-DFF16-NS12	4.14 (105.2)	2.06 (52.4)	3.24 (82.3)	0.58 (14.8)	2.25 (57.2)	1.88 (47.6)	
1	1	SS-DT-DFF16-DFF16-NS16	4.14 (105.2)	2.25 (57.2)	3.24 (82.3)	0.69 (17.5)	2.25 (57.2)	1.88 (47.6)	

Union Crosses

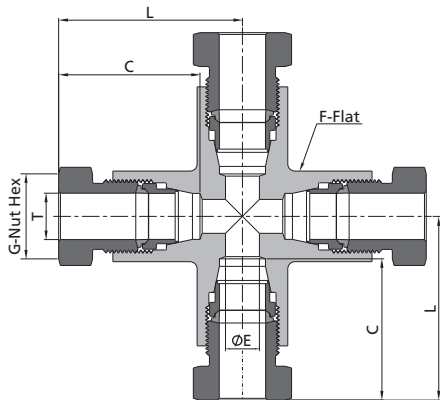

Tube		Dimensions, in. (mm)				
T - Tube O.D. in.	Ordering Number	L	C	E	F	G
1/8	SS-DX-DFF2	1.37 (34.7)	1.07 (27.2)	0.09 (2.4)	0.63 (15.9)	0.37 (9.5)
1/4	SS-DX-DFF4	1.70 (43.1)	1.38 (35.2)	0.19 (4.8)	0.63 (15.9)	0.63 (15.9)
3/8	SS-DX-DFF6	1.67 (42.4)	1.42 (36.1)	0.25 (6.4)	0.75 (19.1)	0.75 (19.1)
1/2	SS-DX-DFF8	2.03 (51.6)	1.56 (39.6)	0.37 (9.5)	1.00 (25.4)	0.94 (23.8)
9/16	SS-DX-DFF9	2.43 (61.8)	1.93 (49.0)	0.41 (10.4)	1.38 (34.9)	1.06 (27.0)
3/4	SS-DX-DFF12	3.01 (76.4)	2.49 (63.3)	0.56 (14.2)	1.50 (38.1)	1.38 (34.9)
1	SS-DX-DFF16	4.14 (105.2)	3.24 (82.3)	0.69 (17.5)	2.25 (57.2)	1.88 (47.6)

### Reducers<sup>①</sup>

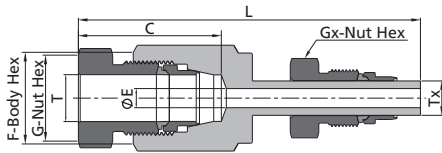

Tube			Dimensions, in. (mm)						
T - Tube O.D. in.	Tx - Tube O.D. in.	Ordering Number	L	C	E	F	G	Gx	
1/4	3/8	SS-DR-DFF4-DFT6	3.20 (82.1)	1.38 (35.2)	0.19 (4.8)	0.63 (15.9)	0.63 (15.9)	0.75 (19.1)	
1/4	1/2	SS-DR-DFF4-DFT8	3.37 (85.5)	1.38 (35.2)	0.19 (4.8)	0.63 (15.9)	0.63 (15.9)	0.94 (23.8)	
3/8	1/2	SS-DR-DFF6-DFT8	3.43 (87.1)	1.42 (36.1)	0.25 (6.4)	0.75 (19.1)	0.75 (19.1)	0.94 (23.8)	
1/2	3/8	SS-DR-DFF8-DFT6	3.53 (89.7)	1.56 (39.6)	0.21 (5.3)	1.00 (25.4)	0.94 (23.8)	0.75 (19.1)	
1/2	3/4	SS-DR-DFF8-DFT12	5.13 (130.4)	1.56 (39.6)	0.37 (9.5)	1.00 (25.4)	0.94 (23.8)	1.38 (34.9)	
9/16	3/4	SS-DR-DFF9-DFT12	5.32 (135.1)	1.93 (49.0)	0.41 (10.4)	1.13 (28.6)	1.06 (27.0)	1.38 (34.9)	
3/4	9/16	SS-DR-DFF12-DFT9	5.46 (138.6)	2.49 (63.3)	0.31 (7.9)	1.50 (38.1)	1.38 (34.9)	1.06 (27.0)	
1	3/4	SS-DR-DFF16-DFT12	6.92 (175.7)	3.24 (82.3)	0.42 (10.7)	2.00 (50.8)	1.88 (47.6)	1.38 (34.9)	

① The right ends of reducers will be preassembled with ferrules before shipping. Please follow the Reinstallation Instructions in A-107 when installing the reducers.

### Port Connectors<sup>①</sup>

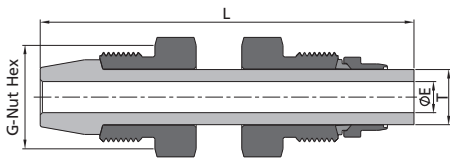

① The port connectors will be preassembled with ferrules before shipping. Please follow the Reinstallation Instructions in A-107 when installing the port connectors.

Tube		Dimensions, in. (mm)		
T - Tube O.D. in.	Ordering Number	L	E	G
1/8	SS-DP-DFF2	2.06 (52.2)	0.06 (1.6)	0.37 (9.5)
1/4	SS-DP-DFF4	2.66 (67.5)	0.12 (3.0)	0.63 (15.9)
3/8	SS-DP-DFF6	2.72 (69.0)	0.21 (5.3)	0.75 (19.1)
1/2	SS-DP-DFF8	3.04 (77.3)	0.28 (7.1)	0.94 (23.8)
9/16	SS-DP-DFF9	3.80 (96.5)	0.31 (7.9)	1.06 (27.0)
3/4	SS-DP-DFF12	4.83 (122.8)	0.42 (10.7)	1.38 (34.9)
1	SS-DP-DFF16	5.98 (152.0)	0.66 (16.7)	1.88 (47.6)

### Adapters<sup>①</sup>

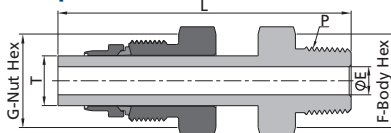

Tube			NPT Thread			
T - Tube O.D. in.	P - NPT Size	Ordering Number	Dimensions, in. (mm)			
			L	E	F	G
1/4	1/4	SS-DAM-DFT4-NS4	2.30 (58.5)	0.12 (3.0)	0.56 (14.3)	0.63 (15.9)
3/8	1/4	SS-DAM-DFT6-NS4	2.38 (60.4)	0.21 (5.3)	0.56 (14.3)	0.75 (19.1)
3/8	1/2	SS-DAM-DFT6-NS8	2.67 (67.9)	0.21 (5.3)	0.87 (22.2)	0.75 (19.1)
1/2	1/4	SS-DAM-DFT8-NS4	2.55 (64.8)	0.25 (6.4)	0.56 (14.3)	0.94 (23.8)
1/2	1/2	SS-DAM-DFT8-NS8	2.84 (72.2)	0.28 (7.1)	0.87 (22.2)	0.94 (23.8)
9/16	1/2	SS-DAM-DFT9-NS8	3.64 (92.4)	0.31 (7.9)	0.87 (22.2)	1.06 (27.0)
3/4	3/4	SS-DAM-DFT12-NS12	4.39 (111.6)	0.42 (10.7)	1.06 (27.0)	1.38 (34.9)
1	1	SS-DAM-DFT16-NS16	5.43 (137.9)	0.66 (16.7)	1.38 (34.9)	1.88 (47.6)

① The adapters will be preassembled with ferrules before shipping. Please follow the Reinstallation Instructions in A-107 when installing the adapters.

## Installation Instructions

Please see A-110.

## Connection Information

Please see A-02.

Fittings
Tubing
Quick Couplings
Line Filters
Valves
Sour Service Products
Subsea Valves
Part Number Crossover Charts

## Ordering Number Description

