

Hoses and Connectors

MH, MM, PS, MP, TH and HC Series

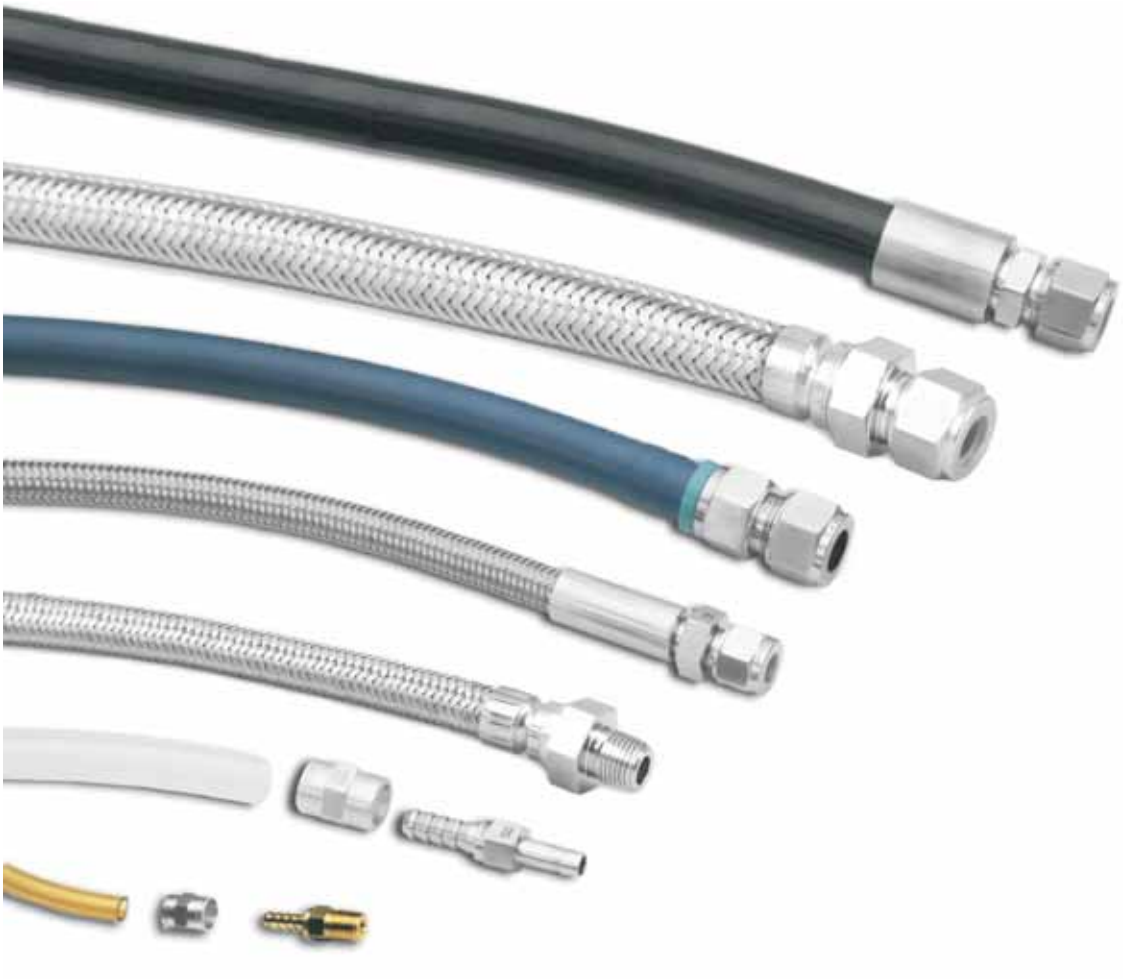

Hoses
Quick-connects

Contents

Metal Flexible Hoses

MH, MM Series



D-04

PTFE-lined, Stainless Steel Braided Hoses

PS Series



D-10

Multipurpose Push-on Hoses

MP Series



D-14

Thermoplastic Hoses

TH Series



D-18

Hose Connectors and Sleeves

HC Series



D-20

Metal Flexible Hoses

MH, MM Series

Features

- ⦿ Core tube and fitting material: 316 stainless steel
- ⦿ Overbraid material: 304 stainless steel (316 SS available)
- ⦿ Vacuum and positive pressure applications
- ⦿ Working pressure up to: 3100 psig (213 bar)
- ⦿ Hose size: 1/4" to 2"
- ⦿ Working temperature: -325°F to 800°F (-200°C to 426°C)
- ⦿ End connections:
 - 1/4" to 2" thread
 - 1/4" to 2" and 6 mm to 50 mm tube fitting
- ⦿ Welded fitting-to-hose construction to ensure reliable seal
- ⦿ Standard and custom length available

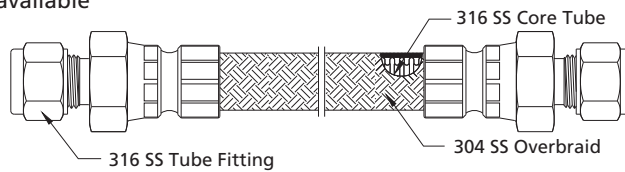

Hose Technical Data (MH Series)

Nominal Hose Size	Inside Diameter	Min. Bend Radius		Temperature Range	Working Pressure at 70°F (20°C)	Burst Pressure at 70°F (20°C)	Hose Series
		Static	Dynamic				
in. (mm)	in. (mm)	in. (mm)	in. (mm)	°F (°C)	psig (bar)	psig (bar)	
1/4 (6.4)	0.28 (7.1)	2.25 (57.2)	10.0 (254)	-325 to 800 (-200 to 426)	3100 (213)	12400 (854)	MH4
3/8 (9.7)	0.42 (10.6)	3.00 (76.2)	12.0 (305)		2000 (137)	8000 (551)	MH6
1/2 (12.7)	0.53 (13.5)	4.50 (114)	16.0 (406)		1800 (124)	7200 (496)	MH8
3/4 (19.0)	0.80 (20.3)	6.00 (152)	17.0 (432)		1500 (103)	6000 (413)	MH12
1 (25.4)	1.03 (26.0)	6.75 (171)	20.0 (508)		1200 (82.6)	4800 (330)	MH16
1 1/4 (31.8)	1.30 (33.0)	8.86 (225)	23.0 (584)		950 (65.4)	3800 (261)	MH20
1 1/2 (38.1)	1.53 (38.9)	11.0 (280)	26.0 (660)		900 (62.0)	3600 (248)	MH24
2 (50.8)	2.05 (52.1)	13.8 (350)	32.0 (813)		500 (34.4)	2000 (137)	MH32

Hose Technical Data (MM Series)

Nominal Hose Size	Inside Diameter	Min. Bend Radius				Temperature Range	Working Pressure at 70°F (20°C)	Burst Pressure at 70°F (20°C)	Hose Series
		Helical Convoluted Core		Annular Convoluted Core					
		Static	Dynamic	Static	Dynamic				
in. (mm)	in. (mm)	in. (mm)	in. (mm)	in. (mm)	in. (mm)	°F (°C)	psig (bar)	psig (bar)	
1/4 (6.4)	0.25 (6.4)	1.38 (35)	8.66 (220)	0.79 (20)	4.33 (110)	-325 to 800 (-200 to 426)	1600 (110)	6400 (440)	MM4
3/8 (9.7)	0.38 (9.5)	2.36 (60)	10.40 (264)	0.98 (25)	5.91 (150)		1470 (101)	6000 (413)	MM6
1/2 (12.7)	0.50 (12.7)	2.95 (75)	11.89 (302)	1.18 (30)	4.88 (124)		1110 (76.4)	4500 (310)	MM8
3/4 (19.0)	0.75 (19.0)	3.54 (90)	13.58 (345)	1.50 (38)	6.65 (169)		860 (59.2)	3500 (241)	MM12
1 (25.4)	1.00 (25.4)	4.13 (105)	15.00 (381)	1.77 (45)	7.68 (195)		680 (46.8)	2680 (184)	MM16
1 1/4 (31.8)	1.25 (31.8)	4.72 (120)	16.22 (412)	/			680 (46.8)	2600 (179)	MM20
1 1/2 (38.1)	1.50 (38.1)	5.51 (140)	16.89 (429)				520 (35.8)	2200 (151)	MM24
2 (50.8)	2.00 (50.8)	6.30 (160)	18.43 (468)				450 (31.0)	1800 (124)	MM32

Testing

Every FITOK metal flexible hose assembly is factory tested with helium to a maximum leak rate of 1×10^{-5} std cm^3/s .

Cleaning and Packaging

FITOK metal flexible hose components are cleaned in accordance with FITOK *Standard Cleaning and Packaging Process (FC-01)* for general industrial procedures.

Shorter hoses are packed in cartons with suitable protective material, longer hoses are coiled, bagged and boxed or crated.

Pressure vs. Temperature

MH series

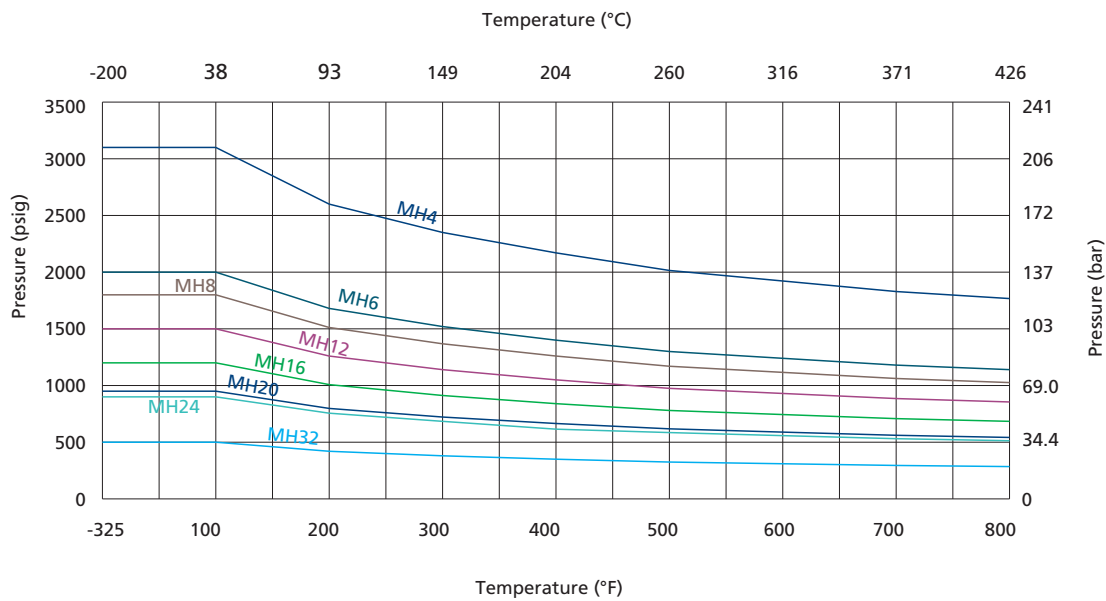

MM series

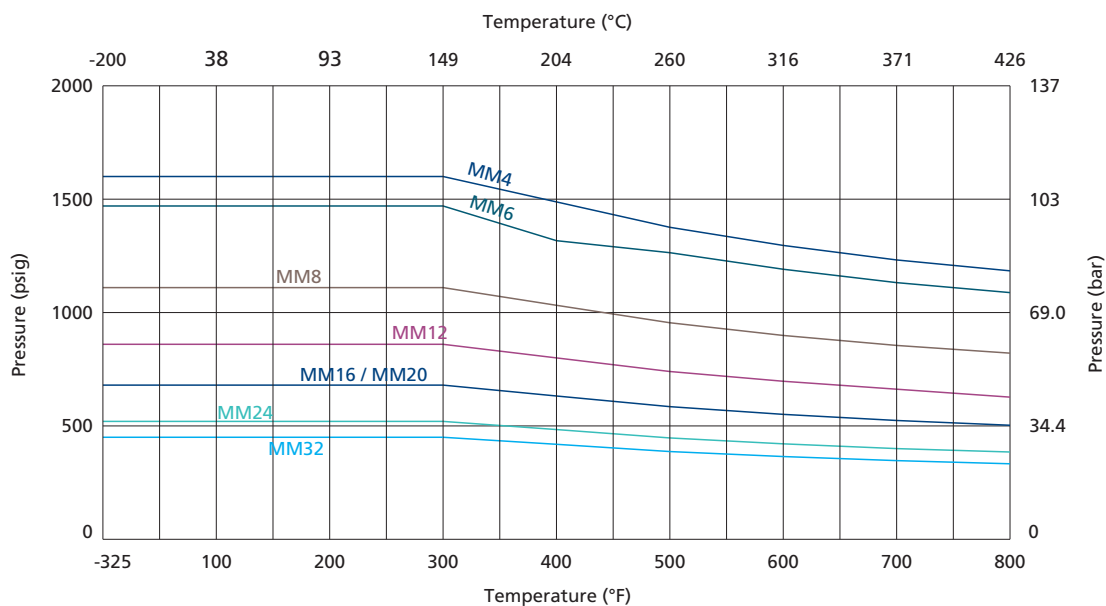

When pulsating, surge, or shock pressures exist, the peak pressure in the system should not exceed 50% of the rated working pressure of the hose.

Standard Assemblies

Tube Fitting to Male NPT End

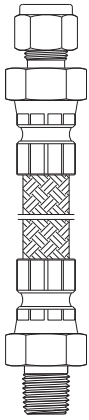

Nominal Hose Size	Tube Fitting Size	NPT Size	Hose Series	Overall Length	Ordering Number	Minimum Inside Diameter	Maximum Outside Dimension
				in. (mm)		in. (mm)	in. (mm)
1/4	1/4	1/4	MH4	12 (305)	SS-MH4-FL4-NS4-F12	0.19 (4.8)	0.94 (23.8)
			MM4	36 (914)	SS-MM4-FL4-NS4-F36	0.19 (4.8)	0.87 (22.0)
3/8	3/8	3/8	MH6	18 (457)	SS-MH6-FL6-NS6-F18	0.28 (7.1)	1.09 (27.7)
			MM6	36 (914)	SS-MM6-FL6-NS6-F36	0.28 (7.1)	1.01 (25.7)
1/2	1/2	1/2	MH8	18 (457)	SS-MH8-FL8-NS8-F18	0.41 (10.4)	1.23 (31.3)
			MM8	48 (1220)	SS-MM8-FL8-NS8-F48	0.41 (10.4)	1.23 (31.3)
3/4	3/4	3/4	MH12	18 (457)	SS-MH12-FL12-NS12-F18	0.66 (16.0)	1.74 (44.2)
			MM12	48 (1220)	SS-MM12-FL12-NS12-F48	0.66 (16.0)	1.59 (40.5)
1	1	1	MH16	24 (610)	SS-MH16-FL16-NS16-F24	0.88 (22.4)	1.82 (46.3)

Tube Fitting End

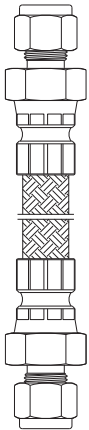

Nominal Hose Size	Tube Fitting Size	Hose Series	Overall Length	Ordering Number	Minimum Inside Diameter	Maximum Outside Dimension
			in. (mm)		in. (mm)	in. (mm)
1/4	1/4	MH4	12 (305)	SS-MH4-FL4-F12	0.19 (4.8)	0.94 (23.8)
		MM4	36 (914)	SS-MM4-FL4-F36	0.19 (4.8)	0.87 (22.0)
3/8	3/8	MH6	18 (457)	SS-MH6-FL6-F18	0.28 (7.1)	1.09 (27.7)
		MM6	36 (914)	SS-MM6-FL6-F36	0.28 (7.1)	1.01 (25.7)
1/2	1/2	MH8	18 (457)	SS-MH8-FL8-F18	0.41 (10.4)	1.23 (31.3)
		MM8	48 (1220)	SS-MM8-FL8-F48	0.41 (10.4)	1.23 (31.3)
3/4	3/4	MH12	18 (457)	SS-MH12-FL12-F18	0.66 (16.0)	1.74 (44.2)
		MM12	48 (1220)	SS-MM12-FL12-F48	0.66 (16.0)	1.59 (40.5)
1	1	MH16	24 (610)	SS-MH16-FL16-F24	0.88 (22.4)	1.82 (46.3)

Tube Adapter End

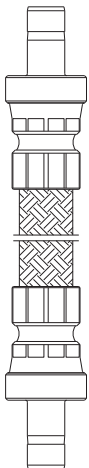

Nominal Hose Size	Tube Adapter Size	Hose Series	Overall Length	Ordering Number	Minimum Inside Diameter	Maximum Outside Dimension
			in. (mm)		in. (mm)	in. (mm)
1/4	1/4	MH4	12 (305)	SS-MH4-FT4-F12	0.16 (4.1)	0.81 (20.6)
		MM4	36 (914)	SS-MM4-FT4-F36	0.16 (4.1)	0.76 (19.2)
3/8	3/8	MH6	12 (305)	SS-MH6-FT6-F12	0.27 (6.9)	1.01 (25.6)
		MM6	36 (914)	SS-MM6-FT6-F36	0.27 (6.9)	0.91 (23.1)

1. All dimensions are for reference only and are subject to change. For dimensions not shown above, please contact FITOK Group or our authorized distributors.
2. Types listed are standard. Other types are available upon request.

End Connections

Tube Adapters

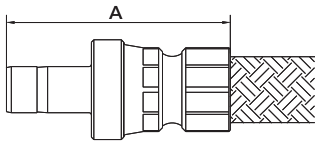

Tube Adapter Size	Nominal Hose Size	End Connection Designator	Dimensions		
			A	Minimum Inside Diameter	Maximum Outside Dimension
in.	in.		in. (mm)		
1/4	1/4	FT4	1.76 (44.7)	0.16 (4.1)	0.81 (20.6)
3/8	3/8	FT6	1.82 (46.2)	0.27 (6.9)	1.01 (25.6)
1/2	1/2	FT8	2.22 (56.4)	0.37 (9.4)	1.23 (31.3)
3/4	3/4	FT12	2.35 (59.7)	0.58 (14.7)	1.53 (38.8)
1	1	FT16	2.69 (68.3)	0.80 (20.3)	1.82 (46.3)
mm	in.	—	mm (in.)		
6	1/4	MT6	44.4 (1.75)	4.1 (0.16)	20.6 (0.81)
10	3/8	MT10	47.0 (1.85)	7.1 (0.28)	25.6 (1.01)
12	1/2	MT12	57.2 (2.25)	8.9 (0.35)	31.3 (1.23)

Tube Fittings

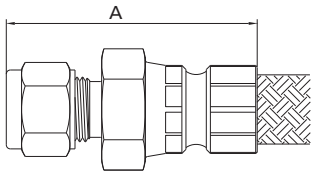

Automatic Weld Style-1 in. and Under

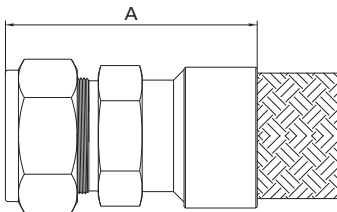

Manual Weld Style-Over 1 in.

Tube Fitting Size	Nominal Hose Size	End Connection Designator	Dimensions		
			A	Minimum Inside Diameter	Maximum Outside Dimension
in.	in.		in. (mm)		
1/4	1/4	FL4	1.94 (49.3)	0.19 (4.8)	0.94 (23.8)
3/8	1/4	FL6	2.00 (50.8)	0.28 (7.1)	0.94 (23.8)
3/8	3/8	FL6	2.02 (51.3)	0.28 (7.1)	1.09 (27.7)
1/2	1/2	FL8	2.24 (56.9)	0.41 (10.4)	1.23 (31.3)
5/8	1/2	FL10	2.27 (57.7)	0.50 (12.7)	1.23 (31.3)
3/4	3/4	FL12	2.35 (59.7)	0.63 (16.0)	1.74 (44.2)
1	1	FL16	2.64 (67.1)	0.88 (22.4)	1.82 (46.3)
1 1/4	1 1/4	FL20	4.04 (103)	1.09 (27.7)	2.23 (58.9)
1 1/2	1 1/2	FL24	4.75 (121)	1.34 (34.0)	2.61 (66.3)
2	2	FL32	5.72 (145)	1.88 (47.8)	3.48 (88.4)
mm	in.	—	mm (in.)		
6	1/4	ML6	62.2 (2.45)	4.8 (0.19)	20.6 (0.81)
8	1/4	ML8	63.2 (2.49)	6.4 (0.25)	20.6 (0.81)
10	3/8	ML10	51.6 (2.03)	7.9 (0.31)	31.3 (1.23)
12	1/2	ML12	56.9 (2.24)	9.7 (0.38)	38.8 (1.53)

Male FR Metal Gasket Face Seal Fittings Swivel

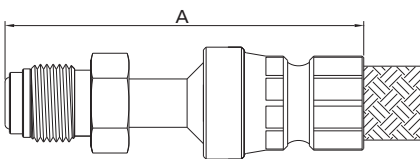

FR Size	Nominal Hose Size	End Connection Designator	Dimensions		
			A	Minimum Inside Diameter	Maximum Outside Dimension
in.	in.		in. (mm)		
1/4	1/4	SFR4	2.60 (66.0)	0.18 (4.6)	0.81 (20.6)
1/2	1/2	SFR8	2.83 (71.9)	0.40 (10.2)	1.23 (31.3)
3/4	3/4	SFR12	4.19 (106)	0.65 (16.5)	1.52 (38.7)
1	1	SFR16	4.80 (122)	0.87 (22.1)	1.53 (38.8)

End Connections

Female FR Metal Gasket Face Seal Fittings Swivel

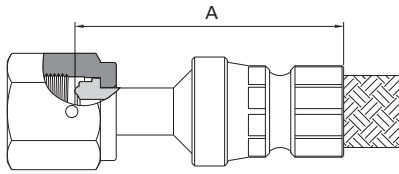

Female FO O-Ring Face Seal Fittings Swivel

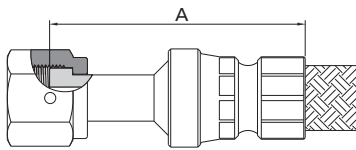

SAE 37° (JIC) Female Swivel

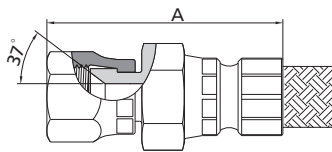

Female Pipe Threads, NPT

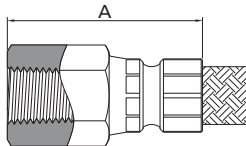

Male Pipe Threads, NPT

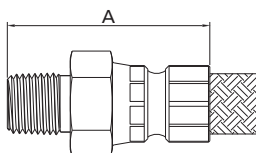

Automatic Weld Style-1 in. and Under

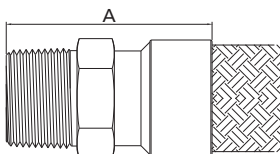

Manual Weld Style-Over 1 in.

FR Size	Nominal Hose Size	End Connection Designator	Dimensions		
			A	Minimum Inside Diameter	Maximum Outside Dimension
in.	in.		in. (mm)		
1/4	1/4	SFFR4	2.00 (50.8)	0.18 (4.6)	0.87 (22.1)
1/2	1/2	SFFR8	2.16 (54.9)	0.40 (10.2)	1.23 (31.3)
3/4	3/4	SFFR12	4.19 (106)	0.65 (16.5)	1.74 (44.2)
1	1	SFFR16	4.80 (122)	0.87 (22.1)	2.03 (51.6)

FO Size	Nominal Hose Size	End Connection Designator	Dimensions		
			A	Minimum Inside Diameter	Maximum Outside Dimension
in.	in.		in. (mm)		
1/4	1/4	SFFO4	2.11 (53.6)	0.18 (4.6)	0.81 (20.6)
1/2	1/2	SFFO8	2.14 (54.4)	0.40 (10.2)	1.23 (31.3)

Swivel Size	Nominal Hose Size	End Connection Designator	Dimensions		
			A	Minimum Inside Diameter	Maximum Outside Dimension
in.	in.		in. (mm)		
1/4	1/4	SAN4	1.87 (47.5)	0.17 (4.3)	0.81 (20.6)
3/8	3/8	SAN6	1.98 (50.3)	0.28 (7.1)	1.01 (25.6)
1/2	1/2	SAN8	2.25 (57.2)	0.42 (10.7)	1.23 (31.3)

NPT Size	Nominal Hose Size	End Connection Designator	Dimensions		
			A	Minimum Inside Diameter	Maximum Outside Dimension
in.	in.		in. (mm)		
1/4	1/4	FNS4	1.81 (46.0)	0.28 (7.1)	0.94 (23.9)
3/8	3/8	FNS6	1.87 (47.5)	0.38 (9.7)	1.09 (27.7)
1/2	1/2	FNS8	2.18 (55.4)	0.47 (11.9)	1.23 (31.3)
3/4	3/4	FNS12	2.21 (56.1)	0.72 (18.3)	1.74 (44.2)

NPT Size	Nominal Hose Size	End Connection Designator	Dimensions		
			A	Minimum Inside Diameter	Maximum Outside Dimension
in.	in.		in. (mm)		
1/4	1/4	NS4	1.80 (45.7)	0.28 (7.1)	0.94 (23.9)
1/4	3/8	NS4	1.81 (46.0)	0.28 (7.1)	1.09 (27.7)
3/8	3/8	NS6	1.81 (46.0)	0.38 (9.7)	1.09 (27.7)
1/2	1/4	NS8	1.99 (50.6)	0.47 (11.9)	1.02 (25.8)
1/2	1/2	NS8	2.15 (54.6)	0.47 (11.9)	1.23 (31.3)
3/4	3/4	NS12	2.22 (56.4)	0.63 (16.0)	1.74 (44.2)
1	1	NS16	2.54 (64.5)	0.88 (22.4)	1.82 (46.3)
1 1/4	1 1/4	NS20	3.06 (77.7)	1.09 (27.7)	2.03 (51.6)
1 1/2	1 1/2	NS24	3.72 (94.5)	1.34 (34.0)	2.47 (62.6)
2	2	NS32	4.19 (106)	1.81 (46.0)	3.19 (81.0)

Ordering Number Description

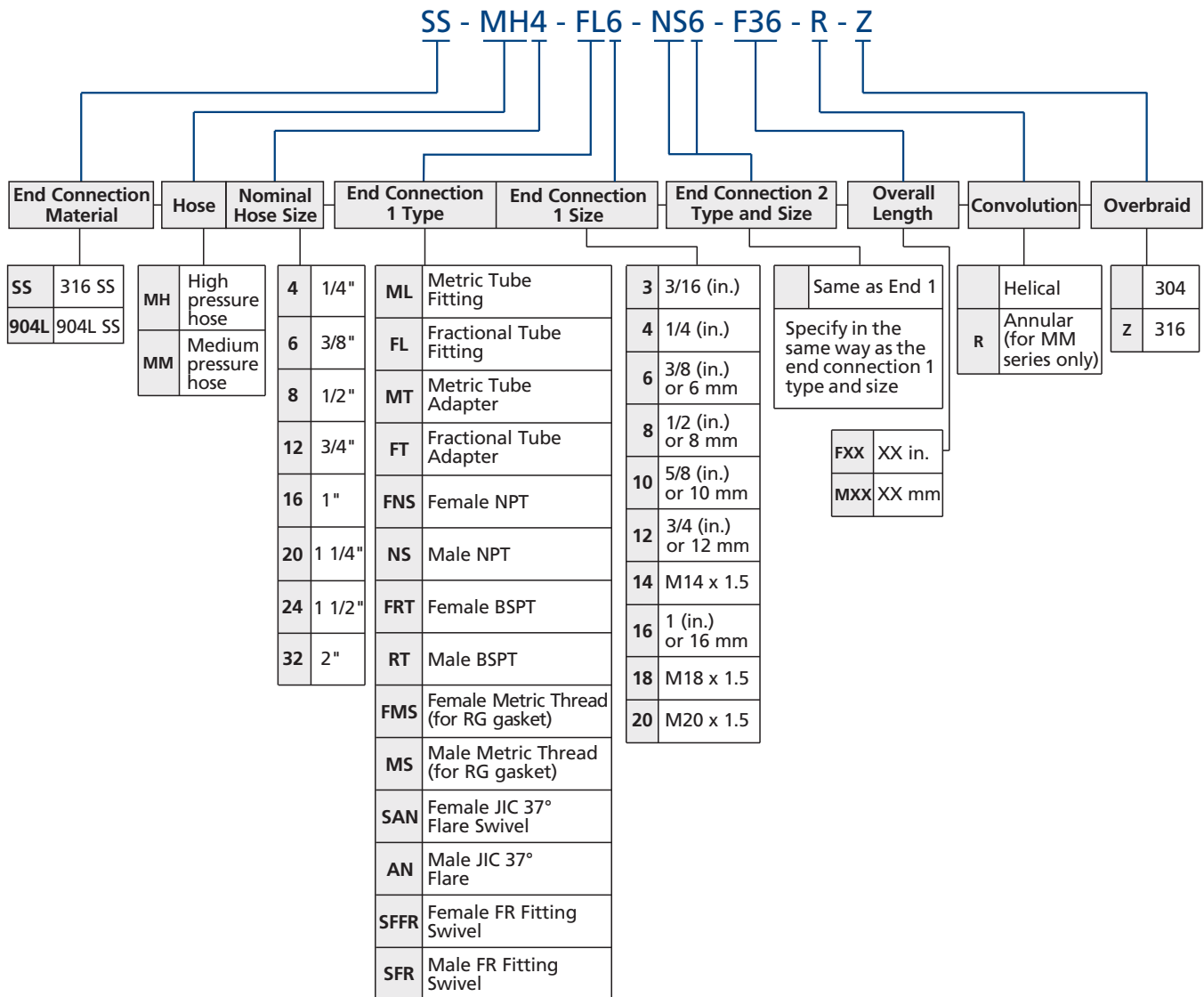

Example: SS-MH4-FT6-M710

SS: End connection material is 316 stainless steel.

MH4: MH series, hose size is 1/4".

FT6: End connection 1 is 3/8" tube adapter.

End connection 2 is 3/8" tube adapter.

M710: Overall length is 710 mm.

End 1 and end 2 follow the orders and regulations below:

1. Metric Double Ferrules - Fractional Double Ferrules - Metric Tube Adapters - Fractional Tube Adapters - NPT Threads - BSPT Threads - BSPP Threads -SAE/MS Parallel Threads - 37° Flare - Others
2. Put the sizes from the biggest down to the smallest if they are of the same type.
3. Put the female before male if they are of the same type and size.

Note: "Ordering Number Description" is a reference to understand the combination rules of FITOK product part number. Not all combinations are available.

PTFE-lined, Stainless Steel Braided Hoses

PS Series

Features

- ⦿ Lightweight construction for easy handling and installation
- ⦿ Core tube material: smooth virgin PTFE
- ⦿ Overbraid material: 304 stainless steel
- ⦿ Working pressure up to: 3000 psig (207 bar)
- ⦿ Hose size: 1/4" to 1"
- ⦿ Working temperature: -65°F to 400°F (-53°C to 204°C)
- ⦿ Standard and custom length available

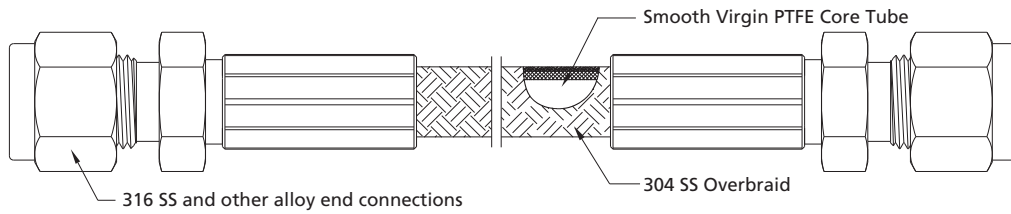

Hose Technical Data

Nominal Hose Size	Inside Diameter	Min. Inside Bend Radius		Temperature Range	Working Pressure at 70°F (20°C)	Burst Pressure at 70°F (20°C)
		Static	Dynamic			
in. (mm)	in. (mm)	in. (mm)	in. (mm)	°F (°C)	psig (bar)	psig (bar)
1/4 (6.4)	0.19 (4.8)	1.5 (38.1)	2.0 (50.8)	-65 to 400 (-53 to 204)	3000 (206)	12000 (826)
3/8 (9.5)	0.31 (7.9)	3.5 (88.9)	5.0 (127)		2500 (172)	10000 (690)
1/2 (12.7)	0.41 (10.3)	4.5 (114)	6.0 (152)		2000 (137)	8000 (551)
3/4 (19.0)	0.63 (15.9)	6.0 (152)	7.5 (190)		1500 (103)	6000 (413)
1 (25.4)	0.88 (22.2)	9.0 (229)	11.3 (287)		1000 (68)	4000 (275)

Pressure vs. Temperature

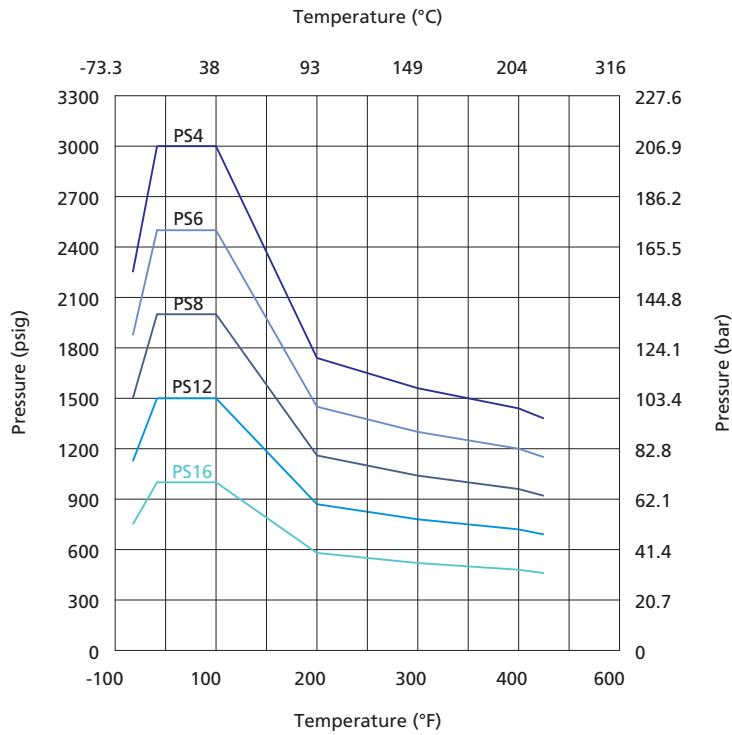

Testing

Every FITOK PTFE-lined hose assembly is factory tested with pure water at 1.5 times the maximum working pressure.

Cleaning and Packaging

FITOK PTFE-lined hose components are cleaned in accordance with FITOK *Standard Cleaning and Packaging Process (FC-01)* for general industrial procedures.

Shorter hoses are packed in cartons with suitable protective material, longer hoses are coiled, bagged and boxed or crated.

PTFE-lined Hose Standard Assemblies

Tube Adapters

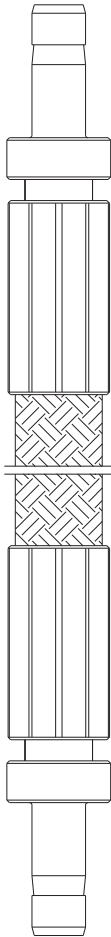

Nominal Hose Size	Tube Adapter Size	Overall Length	Ordering Number	Minimum Inside Diameter	Maximum Outside Dimension
in.	in.	in. (mm)		in. (mm)	in. (mm)
1/4	1/4	6.0 (153)	SS-PS4-FT4-F6	0.16 (4.1)	0.54 (13.7)
		12.0 (305)	SS-PS4-FT4-F12		
		18.0 (458)	SS-PS4-FT4-F18		
		24.0 (610)	SS-PS4-FT4-F24		
		36.0 (915)	SS-PS4-FT4-F36		
		48.0 (1220)	SS-PS4-FT4-F48		
		60.0 (1530)	SS-PS4-FT4-F60		
		72.0 (1829)	SS-PS4-FT4-F72		
		120.0 (3050)	SS-PS4-FT4-F120		
3/8	3/8	12.0 (305)	SS-PS6-FT6-F12	0.27 (6.9)	0.73 (18.5)
		18.0 (458)	SS-PS6-FT6-F18		
		24.0 (610)	SS-PS6-FT6-F24		
		36.0 (915)	SS-PS6-FT6-F36		
		48.0 (1220)	SS-PS6-FT6-F48		
		60.0 (1530)	SS-PS6-FT6-F60		
		72.0 (1829)	SS-PS6-FT6-F72		
		96.0 (2439)	SS-PS6-FT6-F96		
		120.0 (3050)	SS-PS6-FT6-F120		
1/2	1/2	12.0 (305)	SS-PS8-FT8-F12	0.36 (9.1)	0.86 (21.8)
		24.0 (610)	SS-PS8-FT8-F24		
		36.0 (915)	SS-PS8-FT8-F36		
		48.0 (1220)	SS-PS8-FT8-F48		
		60.0 (1530)	SS-PS8-FT8-F60		
		72.0 (1829)	SS-PS8-FT8-F72		
3/4	3/4	24.0 (610)	SS-PS12-FT12-F24	0.53 (13.5)	1.04 (26.4)
		36.0 (915)	SS-PS12-FT12-F36		
1	1	36.0 (915)	SS-PS16-FT16-F36	0.80 (20.3)	1.36 (34.5)
		48.0 (1220)	SS-PS16-FT16-F48		
in.	mm	in. (mm)	—	in. (mm)	in. (mm)
1/4	6	12.0 (305)	SS-PS4-MT6-F12	0.16 (4.1)	0.54 (13.7)
		24.0 (610)	SS-PS4-MT6-F24		
		36.0 (915)	SS-PS4-MT6-F36		
1/2	12	24.0 (610)	SS-PS8-MT12-F24	0.33 (8.4)	0.86 (21.8)
		36.0 (915)	SS-PS8-MT12-F36		

1. All dimensions are for reference only and are subject to change. For dimensions not shown above, please contact FITOK Group or our authorized distributors.
2. Sizes and types listed are standard. Other sizes and types are available on request.

Ordering Number Description

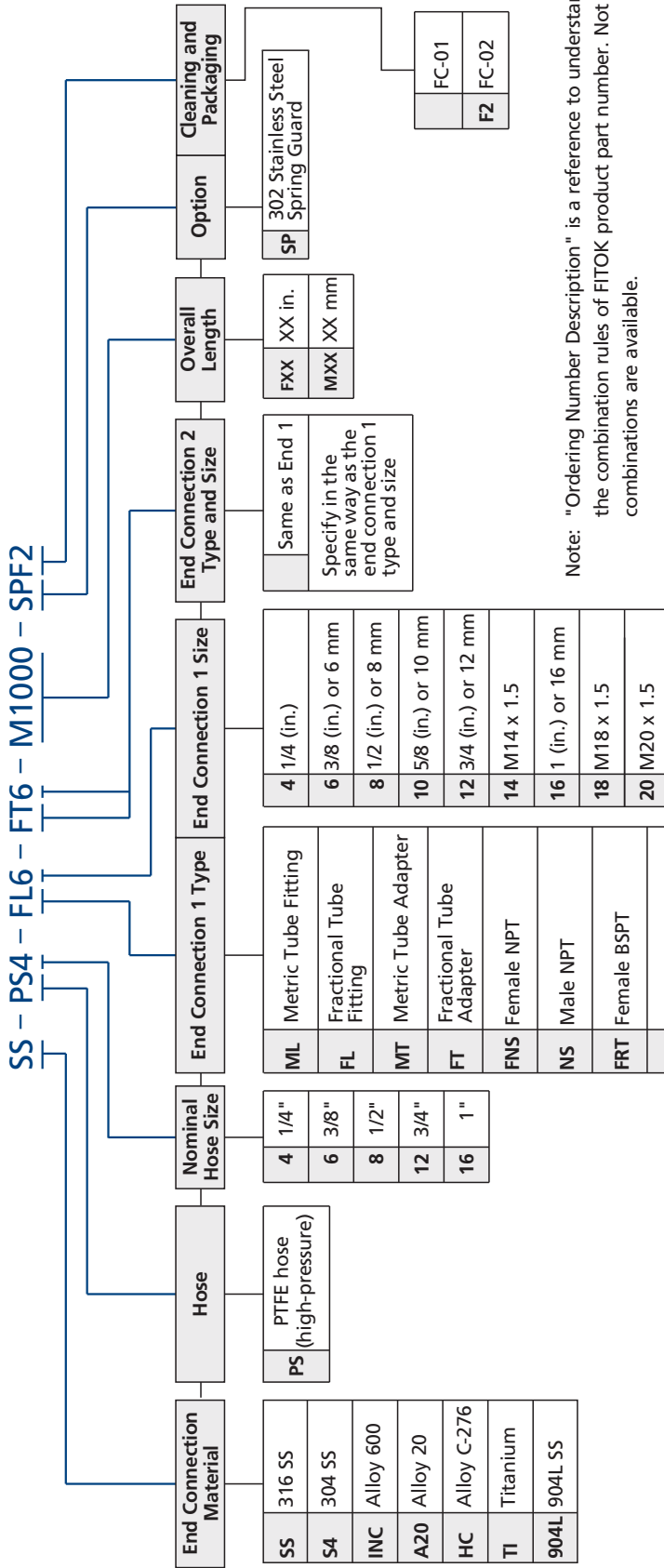

Note: "Ordering Number Description" is a reference to understand the combination rules of FITOK product part number. Not all combinations are available.

- Options and accessories do not change hose technical data. Hose operating parameters must be considered when selecting a cover.
- 302 stainless steel spring guard covers entire hose to protect against kinking and abrasion.

Example: **SS-PS4-SAN4-M500**

SS: End connection material is 316 stainless steel.

PS4: PS series, hose inside diameter is 3/16".

SAN4: End connection 1 is 1/4" female JIC 37° flare swivel.

End connection 2 is 1/4" female JIC 37° flare swivel.

M500: Overall length is 500 mm.

End 1 and end 2 follow the orders and regulations below:

- Metric Double Ferrules - Fractional Double Ferrules - Metric Tube Adapters - Fractional Tube Adapters - NPT Threads - BSPT Threads - SAE/IMS Parallel Threads - 37° Flare - Others
- Put the sizes from the biggest down to the smallest if they are of the same type.
- Put the female before male if they are of the same type and size.

Multipurpose Push-on Hoses

MP Series

Features

- ⦿ Cover: weatherproof, abrasion withstanding and oil-resistant synthetic rubber
- ⦿ Reinforcement: single-braid high-strength synthetic fiber woven for maximum strength and end connection retention
- ⦿ Core tube: highly oil-resistant rubber
- ⦿ Hose colors: blue, black, green, gray, red and yellow
- ⦿ Working pressure up to: 300 psig (20.7 bar)
- ⦿ Hose size: 1/4" to 3/4"
- ⦿ Working temperature: -40°F to 200°F (-40°C to 93°C)
- ⦿ End connection materials: stainless steel and brass
- ⦿ End connections reusable
- ⦿ Custom length available

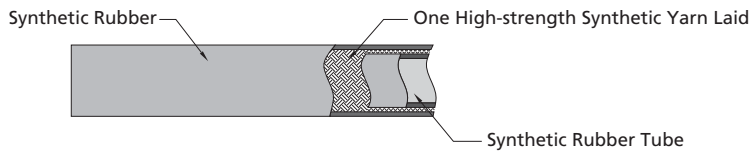

Hose Technical Data

Nominal Hose Size	Inside Diameter	Min. Inside Bend Radius	Temperature Range	Working Pressure at -40 to 70°F (-40 to 20°C)	Min. Burst Pressure at 70°F (20°C)
in. (mm)	in. (mm)	in. (mm)	°F(°C)	psig (bar)	psig (bar)
1/4 (6.4)	0.26 (6.6)	2.50 (63.5)	-40 to 200 (-40 to 93)	300 (20.6)	1200 (82.7)
3/8 (9.5)	0.39 (9.9)	3.00 (76.2)			
1/2 (12.7)	0.50 (12.7)	5.00 (127)			
3/4 (19.0)	0.76 (19.3)	7.00 (178)			

Pressure vs. Temperature

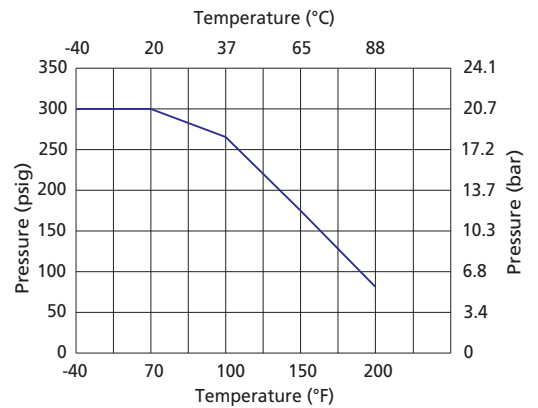

Testing

Every FITOK multipurpose push-on hose assembly is factory tested with pure water at 1.5 times the maximum working pressure.

Cleaning and Packaging

FITOK multipurpose push-on hose components are cleaned in accordance with FITOK *Standard Cleaning and Packaging Process (FC-01)* for general industrial procedures.

Shorter hoses are packed in cartons with suitable protective material, longer hoses are coiled, bagged and boxed or crated.

Multipurpose Push-on Hose End Connections

Tube Fittings

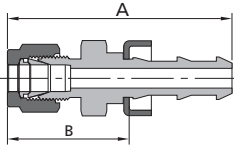

Nominal Hose Size	Tube Fitting Size	Basic Ordering Number	Dimensions, in. (mm)			
			A	B	Minimum Inside Diameter	Maximum Outside Dimension
in.	in.					
1/4	1/4	-MP4-FL4	1.97 (50.0)	1.21 (30.7)	0.16 (4.1)	0.67 (17.0)
3/8	3/8	-MP6-FL6	2.11 (53.6)	1.24 (31.5)	0.27 (6.9)	0.87 (22.1)
1/2	1/2	-MP8-FL8	2.47 (62.7)	1.42 (36.1)	0.37 (9.5)	1.02 (25.8)

Tube Adapters

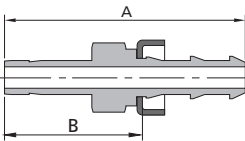

Nominal Hose Size	Tube Adapter Size	Basic Ordering Number	Dimensions, in. (mm)			
			A	B	Minimum Inside Diameter	Maximum Outside Dimension
in.	in.					
1/4	1/4	-MP4-FT4	1.93 (49.0)	1.17 (29.7)	0.15 (3.8)	0.67 (17.0)
3/8	3/8	-MP6-FT6	2.03 (51.6)	1.16 (29.5)	0.24 (6.1)	0.83 (21.1)
1/2	1/2	-MP8-FT8	2.47 (62.7)	1.42 (36.1)	0.34 (8.7)	0.98 (24.9)
3/4	3/4	-MP12-FT12	3.14 (79.8)	1.48 (37.6)	0.57 (14.5)	1.23 (31.3)
in.	mm	—	mm(in.)			
1/4	6	-MP4-MT6	49.0 (1.93)	29.7 (1.17)	3.8 (0.15)	17.0 (0.67)
1/4	8	-MP4-MT8	48.8 (1.92)	29.5 (1.16)	4.1 (0.16)	17.0 (0.67)
3/8	8	-MP6-MT8	52.1 (2.05)	30.0 (1.18)	5.6 (0.22)	21.1 (0.83)
3/8	10	-MP6-MT10	51.6 (2.03)	29.5 (1.16)	6.9 (0.27)	21.1 (0.83)
1/2	12	-MP8-MT12	62.7 (2.47)	36.1 (1.42)	8.1 (0.32)	24.9 (0.98)
3/4	18	-MP12-MT18	79.8 (3.14)	37.3 (1.47)	8.6 (0.34)	31.3 (1.23)

Male NPT

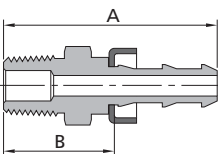

Nominal Hose Size	NPT Size	Basic Ordering Number	Dimensions, in. (mm)			
			A	B	Minimum Inside Diameter	Maximum Outside Dimension
in.						
1/4	1/4	-MP4-NS4	1.68 (42.7)	0.92 (23.4)	0.16 (4.1)	0.67 (17.0)
3/8	1/4	-MP6-NS4	1.80 (45.7)	0.93 (23.6)	0.27 (6.9)	0.83 (21.1)
3/8	3/8	-MP6-NS6	1.80 (45.7)	0.93 (23.6)	0.27 (6.9)	0.83 (21.1)
1/2	1/2	-MP8-NS8	2.19 (55.6)	1.14 (29.0)	0.37 (9.5)	1.02 (25.9)
3/4	3/4	-MP12-NS12	2.81 (71.4)	1.14 (29.0)	0.61 (15.6)	1.31 (33.3)

Male BSPT

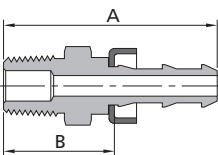

Nominal Hose Size	BSPT Size	Basic Ordering Number	Dimensions, in. (mm)			
			A	B	Minimum Inside Diameter	Maximum Outside Dimension
in.						
1/4	1/4	-MP4-RT4	1.68 (42.7)	0.92 (23.4)	0.16 (4.1)	0.67 (17.0)
3/8	1/4	-MP6-RT4	1.80 (45.7)	0.93 (23.6)	0.27 (6.9)	0.83 (21.1)
3/8	3/8	-MP6-RT6	1.80 (45.7)	0.93 (23.6)	0.27 (6.9)	0.83 (21.1)
1/2	1/2	-MP8-RT8	2.19 (55.6)	1.14 (29.0)	0.37 (9.5)	1.02 (25.9)
3/4	3/4	-MP12-RT12	2.81 (71.4)	1.14 (29.0)	0.61 (15.6)	1.31 (33.3)

D-16 Hoses and Connectors

Unions

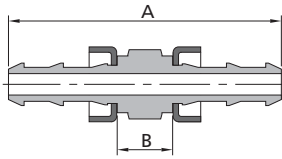

Nominal Hose Size	Basic Ordering Number	Dimensions, in. (mm)			
		A	B	Minimum Inside Diameter	Maximum Outside Dimension
in.					
1/4	-MP4-4	2.07 (52.6)	0.43 (11.4)	0.16 (4.1)	0.67 (17.0)
3/8	-MP6-6	2.25 (57.2)	0.40 (12)	0.27 (6.9)	0.83 (21.1)
1/2	-MP8-8	2.61 (69.8)	0.40 (14)	0.37 (9.5)	0.96 (24.5)
3/4	-MP12-12	3.85 (97.8)	0.47 (12.0)	0.61 (15.6)	1.23 (31.3)

Hose Ordering Number Description

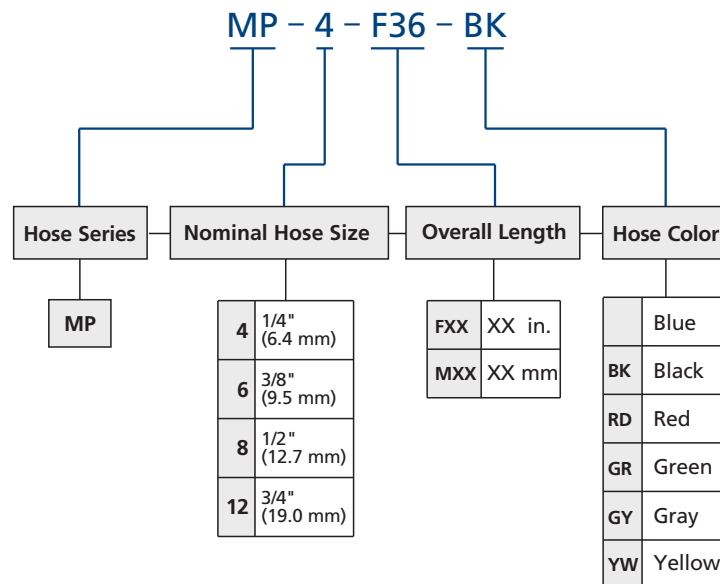

Example: **MP-8-F60-BK**

MP: Hose series

8: Hose size is 1/2".

F60: Overall length is 60".

BK: Hose color is black.

Note: "Ordering Number Description" is a reference to understand the combination rules of FITOK product part number. Not all combinations are available.

Multipurpose Push-On Hose Custom Assemblies



Ordering Number Description

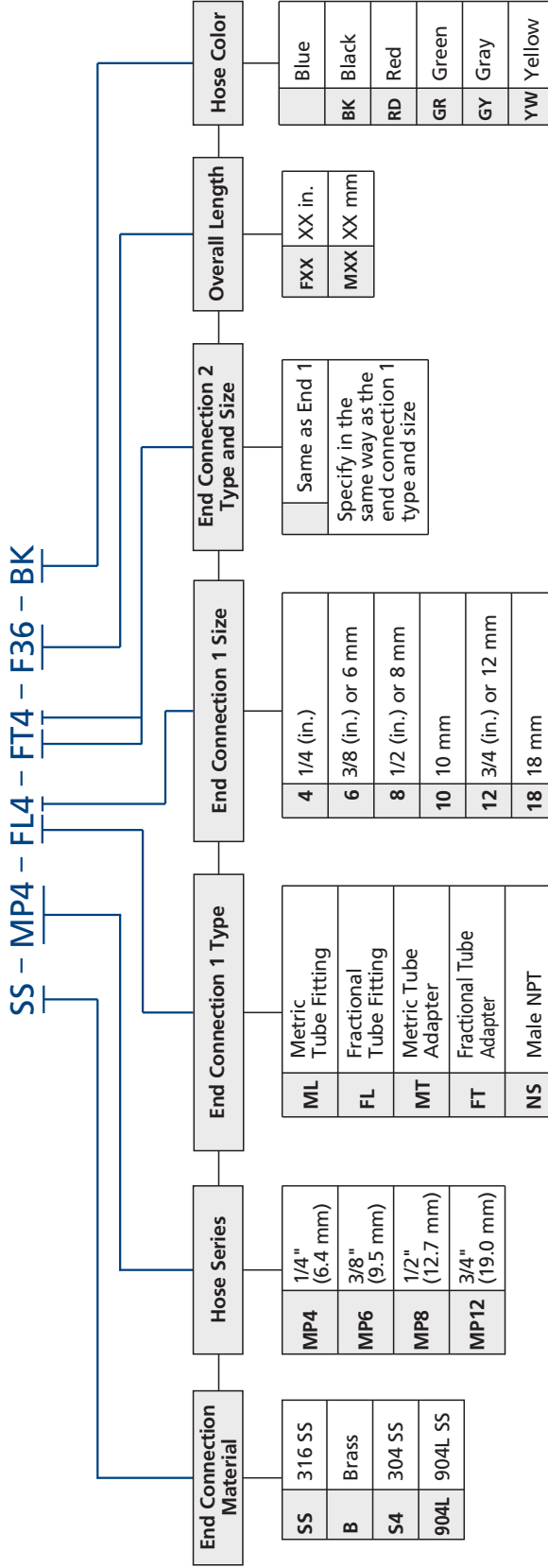

Example: **SS-MP4-FT4-F28-BK**

SS: End connection material is 316 stainless steel.

MP4: MP series, hose size is 1/4" .

FT4: End connection 1 is 1/4" tube adapter.

End connection 2 is 1/4" tube adapter.

F28: Overall length is 28" .

BK : Hose color is black.

Note: "Ordering Number Description" is a reference to understand the combination rules of FITOK product part number. Not all combinations are available.

End 1 and end 2 follow the orders and regulations below:

1. Metric Double Ferrules - Fractional Double Ferrules - Metric Tube Adapters - Fractional Tube Adapters - NPT Threads - BSPT Threads - SAE/IMS Parallel Threads - 37° Flare - Others
2. Put the sizes from the biggest down to the smallest if they are of the same type.
3. Put the female before male if they are of the same type and size.

Thermoplastic Hoses

TH Series

Features

- Polyurethane cover: resists oil, weather and abrasion
- Reinforcement: double-braid high-strength synthetic fiber
- Core tube: nylon
- Working pressure up to: 5000 psig (345 bar)
- Hose size: 3/16" to 1"
- Working temperature: -40°F to 200°F (-40°C to 93°C)
- End connections: 1/4 to 1" thread, 1/4" to 1" and 6 mm to 22 mm tube fitting
- End connection materials: stainless steel, brass and carbon steel
- Custom length available

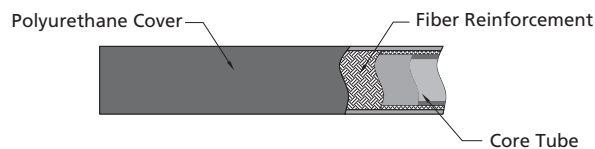

Technical Data

Thermoplastic Hydraulic Hose (SAE 100R7)

Nominal Hose Size	Hose Series	Min. Inside Bend Radius	Inside Diameter	Temperature Range	Working Pressure at 70°F (20°C)	Min. Burst Pressure at 70°F (20°C)	Specification
in. (mm)		in. (mm)	in. (mm)	°F (°C)	psig (bar)	psig (bar)	
3/16 (4.8)	TH3	1.58 (40)	0.19 (4.8)	-40 to 200 (-40 to 93)	3000 (207)	12000 (828)	SAE J517 100R7
1/4 (6.4)	TH4	1.97 (50)	0.25 (6.4)		2750 (189)	11000 (758)	
5/16 (8.0)	TH5	2.36 (60)	0.31 (7.9)		2500 (173)	10000 (690)	
3/8 (9.6)	TH6	2.95 (75)	0.38 (9.8)		2250 (155)	9000 (620)	
1/2 (12.7)	TH8	3.74 (95)	0.50 (12.7)		2000 (137)	8000 (551)	

Thermoplastic Hydraulic Hose (SAE 100R8)

Nominal Hose Size	Hose Series	Min. Inside Bend Radius	Inside Diameter	Temperature Range	Working Pressure at 70°F (20°C)	Min. Burst Pressure at 70°F (20°C)	Specification
in. (mm)		in. (mm)	in. (mm)	°F (°C)	psig (bar)	psig (bar)	
3/16 (4.8)	TH3	2.00 (50.8)	0.19 (4.8)	-40 to 200 (-40 to 93)	5000 (344)	20000 (1378)	SAE J517 100R8
1/4 (6.4)	TH4	2.00 (50.8)	0.25 (6.4)		5000 (344)	20000 (1378)	
3/8 (9.6)	TH6	2.50 (63.5)	0.38 (9.8)		4000 (275)	16000 (1102)	
1/2 (12.7)	TH8	4.00 (102)	0.50 (12.7)		3500 (241)	14000 (964)	
3/4 (19.0)	TH12	6.50 (165)	0.75 (19.0)		2250 (155)	9000 (620)	
1 (25.4)	TH16	10.0 (254)	1.00 (25.4)		2000 (137)	8000 (551)	

Testing

Every FITOK thermoplastic hose assembly is factory tested with pure water at 1.5 times the maximum working pressure.

Cleaning and Packaging

FITOK thermoplastic hose components are cleaned in accordance with FITOK *Standard Cleaning and Packaging Process (FC-01)* for general industrial procedures.

Shorter hoses are packed in cartons with suitable protective material, longer hoses are coiled, bagged and boxed or crated.

Thermoplastic Hose Assemblies



Ordering Number Description

SS – TH4 – FL4 – SAN4 – M1000 – R7

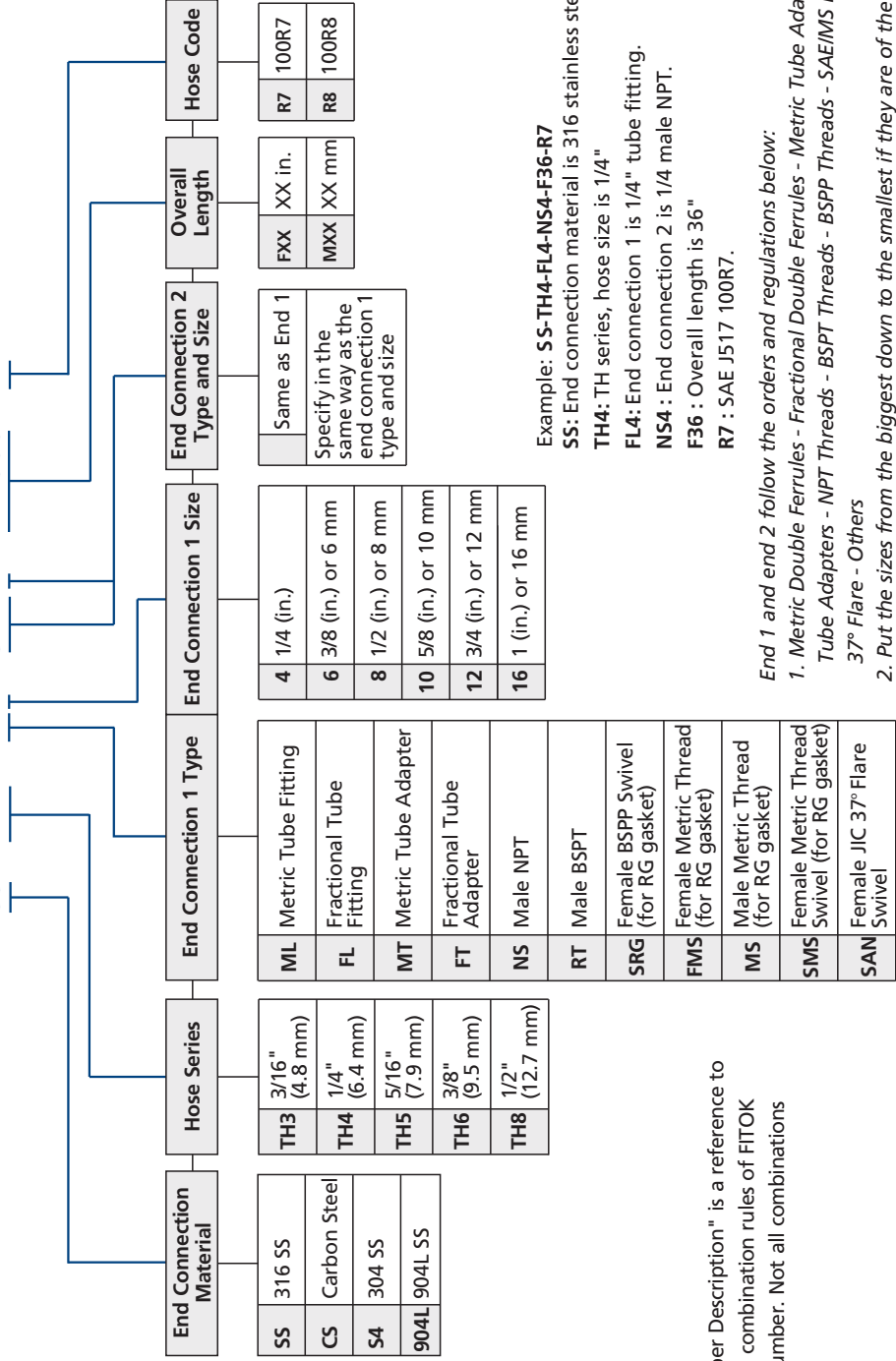

Example: SS-TH4-FL4-NS4-F36-R7

SS: End connection material is 316 stainless steel.

TH4: TH series, hose size is 1/4"

FL4: End connection 1 is 1/4" tube fitting.

NS4 : End connection 2 is 1/4 male NPT.

F36 : Overall length is 36"

R7 : SAE J517 100R7.

End 1 and end 2 follow the orders and regulations below:

1. Metric Double Ferrules - Fractional Double Ferrules - Metric Tube Adapters - Fractional Tube Adapters - NPT Threads - BSPT Threads - BSPP Threads - SAE/MS Parallel Threads - 37° Flare - Others
2. Put the sizes from the biggest down to the smallest if they are of the same type.
3. Put the female before male if they are of the same type and size.

Note: "Ordering Number Description" is a reference to understand the combination rules of FITOK product part number. Not all combinations are available.

Hose Connectors and Sleeves

HC Series

Features

- Used to connect soft plastic or rubber tubing
- Working pressures and working temperatures are wider than those of the connected hoses
- Stainless steel or brass is available
- Shank design holds tubing inside diameter securely
- Hose connectors are reusable



Hose Connectors

Tube Fittings

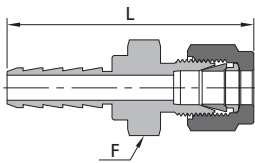

Hose ID	Tube Size	Basic Ordering Number	Dimensions		
			Minimum Inside Diameter	F	L
in.	in.		in. (mm)	in.	in. (mm)
1/8	1/8	-HC-F2-FL2	0.08 (2.0)	7/16	1.42 (36.1)
1/4	1/8	-HC-F4-FL2	0.09 (2.3)	7/16	1.81 (46.0)
	1/4	-HC-F4-FL4	0.19 (4.8)	9/16	1.92 (48.8)
3/8	1/4	-HC-F6-FL4	0.19 (4.8)	9/16	1.99 (50.6)
	3/8	-HC-F6-FL6	0.28 (7.1)	3/4	2.06 (52.3)
1/2	1/2	-HC-F8-FL8	0.38 (9.7)	7/8	2.24 (56.9)
mm	mm	—	mm (in.)	mm	mm (in.)
6	6	-HC-M6-ML6	4.8 (0.19)	14	49.5 (1.95)
8	8	-HC-M8-ML8	6.4 (0.25)	16	49.8 (1.96)
	10	-HC-M8-ML10	6.4 (0.25)	18	51.6 (2.03)
10	10	-HC-M10-ML10	7.9 (0.31)	19	52.3 (2.06)
12	12	-HC-M12-ML12	9.7 (0.38)	22	57.4 (2.26)

Tube Adapters

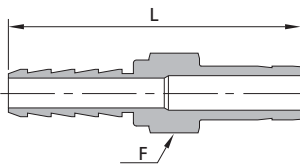

Hose ID	Tube Size	Basic Ordering Number	Dimensions		
			Minimum Inside Diameter	F	L
in.	in.		in. (mm)	in.	in. (mm)
1/8	1/8	-HC-F2-FT2	0.08 (2.0)	5/16	1.37 (34.8)
	1/4	-HC-F2-FT4	0.09 (2.3)	3/8	1.47 (37.3)
1/4	1/4	-HC-F4-FT4	0.19 (4.8)	7/16	1.86 (47.2)
	3/8	-HC-F4-FT6	0.19 (4.8)	7/16	1.92 (48.8)
5/16	1/4	-HC-F5-FT4	0.19 (4.8)	7/16	1.94 (49.3)
3/8	1/4	-HC-F6-FT4	0.19 (4.8)	9/16	1.94 (49.3)
	3/8	-HC-F6-FT6	0.28 (7.1)	9/16	2.00 (50.8)
	1/2	-HC-F6-FT8	0.30 (7.6)	5/8	2.26 (57.4)
1/2	3/8	-HC-F8-FT6	0.28 (7.1)	11/16	2.07 (52.6)
	1/2	-HC-F8-FT8	0.38 (9.7)	11/16	2.33 (59.2)
3/4	3/4	-HC-F12-FT12	0.63 (16.0)	13/16	2.50 (63.5)
1	1	-HC-F16-FT16	0.80 (20.3)	1 3/8	3.03 (77.0)

Male NPT

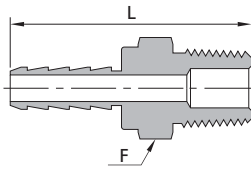

Hose ID	NPT Size	Basic Ordering Number	Dimensions		
			Minimum Inside Diameter	F	L
in.			in. (mm)	in.	in. (mm)
1/8	1/8	-HC-F2-NS2	0.08 (2.0)	7/16	1.08 (27.4)
	1/4	-HC-F2-NS4	0.08 (2.0)	9/16	1.26 (32.0)
3/16	1/8	-HC-F3-NS2	0.13 (3.3)	7/16	1.27 (32.2)
	1/4	-HC-F3-NS4	0.13 (3.3)	9/16	1.45 (36.8)
1/4	1/8	-HC-F4-NS2	0.19 (4.8)	7/16	1.47 (37.3)
	1/4	-HC-F4-NS4	0.19 (4.8)	9/16	1.65 (41.9)
	3/8	-HC-F4-NS6	0.19 (4.8)	11/16	1.66 (42.2)
	1/2	-HC-F4-NS8	0.19 (4.8)	7/8	1.85 (47.0)
5/16	1/8	-HC-F5-NS2	0.19 (4.8)	7/16	1.55 (39.4)
	1/4	-HC-F5-NS4	0.19 (4.8)	9/16	1.73 (43.9)
	3/8	-HC-F5-NS6	0.19 (4.8)	11/16	1.74 (44.2)
	1/2	-HC-F5-NS8	0.19 (4.8)	7/8	1.96 (49.8)
3/8	1/4	-HC-F6-NS4	0.30 (7.6)	9/16	1.73 (43.9)
	3/8	-HC-F6-NS6	0.30 (7.6)	11/16	1.74 (44.2)
	1/2	-HC-F6-NS8	0.30 (7.6)	7/8	1.96 (49.8)
1/2	1/4	-HC-F8-NS4	0.30 (7.6)	11/16	1.80 (45.7)
	3/8	-HC-F8-NS6	0.38 (9.7)	11/16	1.81 (46.0)
	1/2	-HC-F8-NS8	0.38 (9.7)	7/8	2.03 (51.6)
5/8	3/8	-HC-F10-NS6	0.38 (9.7)	1 1/16	1.88 (47.8)
	1/2	-HC-F10-NS8	0.47 (11.9)	1 1/16	2.07 (52.6)
	3/4	-HC-F10-NS12	0.50 (12.7)	1 1/16	2.07 (52.6)
3/4	1/2	-HC-F12-NS8	0.47 (11.9)	1 1/16	2.14 (54.4)
	3/4	-HC-F12-NS12	0.63 (16.0)	1 1/16	2.14 (54.4)
	1	-HC-F12-NS16	0.63 (16.0)	1 3/8	2.43 (61.7)
1	3/4	-HC-F16-NS12	0.63 (16.0)	1 3/8	2.38 (60.5)
	1	-HC-F16-NS16	0.88 (22.4)	1 3/8	2.57 (65.3)

Female NPT

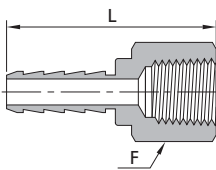

Hose ID	NPT Size	Basic Ordering Number	Dimensions		
			Minimum Inside Diameter	F	L
in.			in. (mm)	in.	in. (mm)
1/8	1/8	-HC-F2-FNS2	0.08 (2.0)	9/16	1.11 (28.2)
	1/4	-HC-F2-FNS4	0.08 (2.0)	3/4	1.26 (32.0)
3/16	1/8	-HC-F3-FNS2	0.13 (3.3)	9/16	1.29 (32.8)
	1/4	-HC-F3-FNS4	0.13 (3.3)	3/4	1.44 (36.6)
1/4	1/8	-HC-F4-FNS2	0.19 (4.8)	9/16	1.47 (37.3)
	1/4	-HC-F4-FNS4	0.19 (4.8)	3/4	1.64 (41.7)
	3/8	-HC-F4-FNS6	0.19 (4.8)	7/8	1.71 (43.4)
5/16	1/4	-HC-F5-FNS4	0.19 (4.8)	3/4	1.73 (43.9)
	3/8	-HC-F5-FNS6	0.19 (4.8)	7/8	1.82 (46.2)
3/8	1/4	-HC-F6-FNS4	0.30 (7.6)	3/4	1.69 (42.9)
	3/8	-HC-F6-FNS6	0.30 (7.6)	7/8	1.78 (45.2)
	1/2	-HC-F6-FNS8	0.30 (7.6)	1 1/16	2.03 (51.6)
1/2	1/2	-HC-F8-FNS8	0.38 (9.7)	1 1/16	2.13 (54.1)

Hoses
Quick-connects

D-22 Hoses and Connectors

Male BSPT

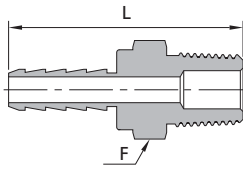

Hose ID	BSPT Size	Basic Ordering Number	Dimensions		
			Minimum Inside Diameter	F	L
in.			in. (mm)	in.	in. (mm)
1/8	1/8	-HC-F2-RT2	0.08 (2.0)	7/16	1.28 (32.5)
	1/4	-HC-F2-RT4	0.08 (2.0)	9/16	1.40 (35.5)
3/16	1/8	-HC-F3-RT2	0.13 (3.3)	7/16	1.40 (35.5)
	1/4	-HC-F3-RT4	0.13 (3.3)	9/16	1.58 (40.1)
1/4	1/8	-HC-F4-RT2	0.19 (4.8)	7/16	1.47 (37.3)
	1/4	-HC-F4-RT4	0.19 (4.8)	9/16	1.65 (41.9)
	3/8	-HC-F4-RT6	0.19 (4.8)	11/16	1.66 (42.2)
	1/2	-HC-F4-RT8	0.19 (4.8)	7/8	1.90 (48.3)
5/16	1/8	-HC-F5-RT2	0.19 (4.8)	7/16	1.67 (42.4)
	1/4	-HC-F5-RT4	0.19 (4.8)	9/16	1.86 (47.2)
	3/8	-HC-F5-RT6	0.19 (4.8)	11/16	1.87 (47.5)
	1/2	-HC-F5-RT8	0.19 (4.8)	7/8	2.10 (53.3)
3/8	1/4	-HC-F6-RT4	0.30 (7.6)	9/16	1.73 (43.9)
	3/8	-HC-F6-RT6	0.30 (7.6)	11/16	1.74 (44.2)
	1/2	-HC-F6-RT8	0.30 (7.6)	7/8	1.96 (49.8)
1/2	1/4	-HC-F8-RT4	0.30 (7.6)	11/16	1.80 (45.7)
	3/8	-HC-F8-RT6	0.38 (9.7)	11/16	1.81 (46.0)
	1/2	-HC-F8-RT8	0.38 (9.7)	7/8	2.03 (51.6)
5/8	3/8	-HC-F10-RT6	0.38 (9.7)	1 1/16	1.88 (47.8)
	1/2	-HC-F10-RT8	0.47 (11.9)	1 1/16	2.07 (52.6)
	3/4	-HC-F10-RT12	0.50 (12.7)	1 1/16	2.07 (52.6)
3/4	1/2	-HC-F12-RT8	0.47 (11.9)	1 1/16	2.14 (54.4)
	3/4	-HC-F12-RT12	0.63 (16.0)	1 1/16	2.14 (54.4)
	1	-HC-F12-RT16	0.63 (16.0)	1 3/8	2.43 (61.7)
1	3/4	-HC-F16-RT12	0.63 (16.0)	1 3/8	2.38 (60.5)
	1	-HC-F16-RT16	0.88 (22.4)	1 3/8	2.57 (65.3)

Female BSPT

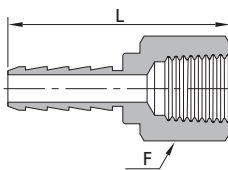

Hose ID	BSPT Size	Basic Ordering Number	Dimensions		
			Minimum Inside Diameter	F	L
in.			in. (mm)	in.	in. (mm)
1/8	1/8	-HC-F2-FRT2	0.08 (2.0)	9/16	1.11 (28.2)
	1/4	-HC-F2-FRT4	0.08 (2.0)	3/4	1.26 (32.0)
3/16	1/8	-HC-F3-FRT2	0.13 (3.3)	9/16	1.29 (32.8)
	1/4	-HC-F3-FRT4	0.13 (3.3)	3/4	1.44 (36.6)
1/4	1/8	-HC-F4-FRT2	0.19 (4.8)	9/16	1.47 (37.3)
	1/4	-HC-F4-FRT4	0.19 (4.8)	3/4	1.64 (41.7)
	3/8	-HC-F4-FRT6	0.19 (4.8)	7/8	1.71 (43.4)
5/16	1/4	-HC-F5-FRT4	0.19 (4.8)	3/4	1.73 (43.9)
	3/8	-HC-F5-FRT6	0.19 (4.8)	7/8	1.82 (46.2)
3/8	1/4	-HC-F6-FRT4	0.30 (7.6)	3/4	1.69 (42.9)
	3/8	-HC-F6-FRT6	0.30 (7.6)	7/8	1.78 (45.2)
	1/2	-HC-F6-FRT8	0.30 (7.6)	1 1/16	2.03 (51.6)
1/2	1/2	-HC-F8-FRT8	0.38 (9.7)	1 1/16	2.13 (54.1)

Metric Thread

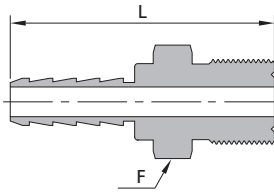

Hose ID	Thread Size	Basic Ordering Number	Dimensions		
			Minimum Inside Diameter	F	L
mm	in.		in. (mm)	mm	in. (mm)
6	M10 x 1	-HC-M6-MS10	4.3 (0.17)	12	39.6 (1.54)
	M12 x 1.5	-HC-M6-MS12	4.3 (0.17)	14	40.4 (1.59)
	M14 x 1.5	-HC-M6-MS14	4.3 (0.17)	15	42.2 (1.66)
8	M14 x 1.5	-HC-M8-MS14	4.8 (0.19)	15	44.2 (1.74)
	M16 x 1.5	-HC-M8-MS16	4.8 (0.19)	18	46.2 (1.82)
10	M16 x 1.5	-HC-M10-MS16	7.9 (0.31)	18	46.2 (1.82)
	M18 x 1.5	-HC-M10-MS18	7.9 (0.31)	19	47.2 (1.86)
12	M20 x 1.5	-HC-M12-MS20	8.9 (0.35)	22	50.3 (1.98)
	M22 x 1.5	-HC-M12-MS22	8.9 (0.35)	24	52.8 (2.08)

Hose Connector Sleeves

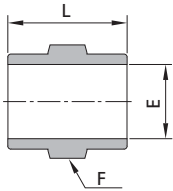

Hose ID	Hose OD	Ordering Number	Dimensions, in. (mm)		
			E	F	L
in.	in.				
1/8	1/4	AL-HC-F2-F4	0.26 (6.6)	3/8	0.40 (10.2)
1/4	3/8	AL-HC-F4-F6	0.41 (10.4)	9/16	0.79 (20.1)
1/4	7/16	AL-HC-F4-F7	0.46 (11.7)	5/8	0.79 (20.1)
1/4	1/2	AL-HC-F4-F8	0.52 (13.2)	11/16	0.79 (20.1)
5/16	7/16	AL-HC-F5-F7	0.48 (12.2)	5/8	0.87 (22.1)
3/8	1/2	AL-HC-F6-F8	0.55 (14.0)	11/16	0.87 (22.1)
3/8	9/16	AL-HC-F6-F9	0.61 (15.5)	3/4	0.87 (22.1)
7/16	5/8	AL-HC-F7-F10	0.69 (17.5)	13/16	0.94 (23.9)
1/2	11/16	AL-HC-F8-F11	0.76 (19.3)	7/8	0.94 (23.9)
3/4	1	AL-HC-F12-F16	1.10 (27.9)	1 1/4	1.07 (27.2)

- ⦿ Material: Aluminum
- ⦿ Reusable

Hose Clamps

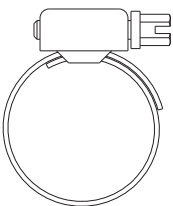

Min. Hose OD	Max. Hose OD	Ordering Number
mm	mm	
8	12	CP8-12
10	16	CP10-16
12	20	CP12-20
16	25	CP16-25
20	32	CP20-32
25	40	CP25-40

- ⦿ Material: 304 SS
- ⦿ Reusable

1. Sizes and types listed are standard. Other sizes and types are available upon request.
2. All dimensions are for reference only and are subject to change. For dimensions not shown above, please contact FITOK Group or our authorized distributors.

Ordering Number Description

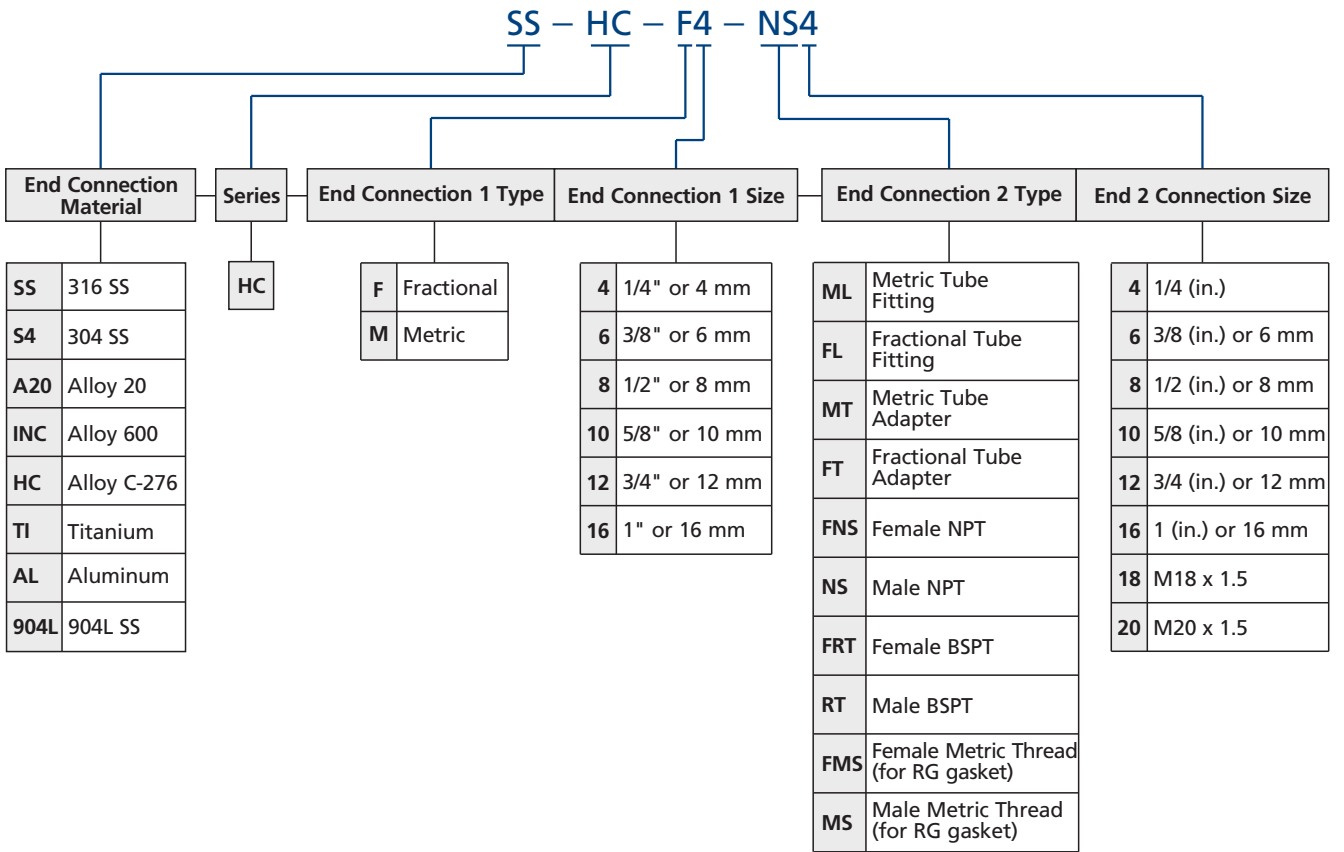

Example: SS-HC-F4-FT6

- SS:** End connection material is 316 stainless steel.
- HC:** HC series.
- F4:** Hose ID is 1/4" .
- FT6:** End connection 2 is 3/8" tube adapter.

Note: "Ordering Number Description" is a reference to understand the combination rules of FITOK product part number. Not all combinations are available.

FITOK Group

FITOK GmbH (Headquarters)

Sprendlinger Landstr. 115, 63069 Offenbach am Main, Germany
Tel.: +49 69 8900 4498 Fax: +49 69 8900 4495

FITOK, Inc.

13843 North Promenade Blvd., Suite 750, Stafford, Texas 77477, USA
Tel.: +1 281 888 0077 Fax: +1 281 582 4051

FITOK Incorporated

1-4F, Block C, Zone E, Yingtai Industrial Park, Dalang Street,
Longhua District, Shenzhen, 518109, China
Tel.: +86 755 2803 2500 Fax: +86 755 2803 2619

FITOK (Suzhou) Metal Products Co., Ltd.

No. 29 Changsheng Road, Yangyuan Industrial Park, Xinzhuang Town,
Changshu, Jiangsu 215562, China
Tel.: +86 512 5247 9001 Fax: +86 512 5247 9002

FITOK Middle East Oil Equipment Trading LLC

208-209, Makateb Building, P.O.Box 185412, Airport Road, Deira, Dubai, UAE
Tel.: +971 4 2959 853 Fax: +971 4 2959 854

FITOK Canada Inc.

5407 Roper Rd. Edmonton, Alberta, T6B 3L6, Canada
Tel.: +1 780 966 8895

info@fitokgroup.com
www.fitokgroup.com

FK-IC-GT-02-EN-190424