

DHL Series Tube Fittings and Tubing

15,000 psig (1034 bar)









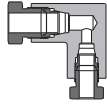

FITOK
Valves and Fittings

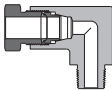
www.fitokgroup.com

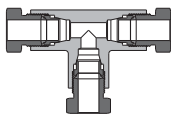
Contents

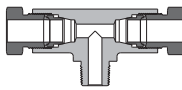
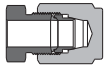
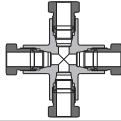
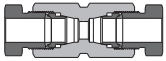
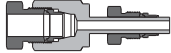
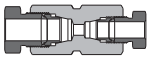
Tube Fittings

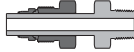
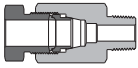
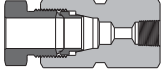
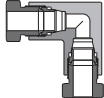
	1				
Nuts - N				Union Reducing Elbows - LU	
	2				5
Front Ferrules - FF				Male Elbows - LM	
	2				6
Rear Ferrules - RF				Union Tees - TTT	
	2				6
Plugs - TP				Male Branch Tees - TTM	
	2				7
Caps - TC				Union Crosses - C	
	2				7
Unions - U				Reducers - R	
	3				8
Reducing Unions - U				Port Connectors - P	
	3				8
Bulkhead Unions - BU				Adapters - AM	
	3				9
Male Connectors - CM				Ordering Number Description	
	4				10
Female Connectors - CF				Ordering Number Description	
	5				10
Union Elbows - LU				Tubing	
	5				11
				Installation Instructions	
					13
				Tools and Accessories	
					15

Tube Fittings

Features

- ⦿ Working pressure up to 15,000 psig (1034 bar)
- ⦿ Double ferrules to compress sleeve
- ⦿ Easy and quick connection to DHL Series tubing
- ⦿ Tubing sizes available in 1/8", 1/4", 3/8", 1/2", 9/16" and 3/4"
- ⦿ High tensile 316 Stainless Steel as raw material
- ⦿ Nut threads coated with molybdenum disulfide-based lubricant to minimize the friction
- ⦿ Every fitting marked with size, material and heat number
- ⦿ Long tube-support area to improve vibration resistance and line loads
- ⦿ 4:1 safety factor

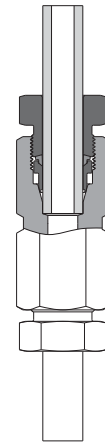

Standard Materials of Construction

Component	Material	Specification
<i>Body, ferrule</i>	<i>316 stainless steel</i>	<i>ASTM A479</i>
Nut	316 stainless steel	ASTM A479

Wetted components listed in italics.

Working Pressure

- ⦿ Working pressure is determined by the lowest working pressure of the ends.

Tube Ends

The working pressure of the tube ends at ambient temperature is determined by the working pressure of the FITOK tubing used. For details, please refer to "Working Pressure of Tubing" on A-14.

Heavy-Duty Stud Ends (SAE J1926-2)

Working pressure for heavy-duty end connections listed in this Catalog is rated to 10,000 psig (690 bar).

NPT Ends

NPT Size in.	Working Pressure psig (bar)
1/8	15,000 (1034)
1/4	
3/8	
1/2	10,000 (690)
3/4	
1	

Working Temperature

Connection Type	Working Temperature Range, °F (°C)
Tube Ends	-325 to 800 (-198 to 427)
Heavy-Duty Stud Ends (SAE J1926-2)	0 to 400 (-17.8 to 204)
NPT Ends	-325 to 400 (-198 to 204)

2 DHL Series Tube Fittings and Tubing

Nuts

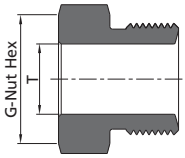

Tube		
T - Tube O.D. in.	Ordering Number	Dimensions, in. (mm)
		G
1/8	SS-N-DHL2	0.37 (9.5)
1/4	SS-N-DHL4	0.63 (15.9)
3/8	SS-N-DHL6	0.75 (19.1)
1/2	SS-N-DHL8	0.94 (23.8)
9/16	SS-N-DHL9	1.06 (27.0)
3/4	SS-N-DHL12	1.38 (34.9)

Front Ferrules

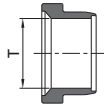

Tube	
T - Tube O.D. in.	Ordering Number
1/8	SS-FF-DHL2
1/4	SS-FF-DHL4
3/8	SS-FF-DHL6
1/2	SS-FF-DHL8
9/16	SS-FF-DHL9
3/4	SS-FF-DHL12

Rear Ferrules



Tube	
T - Tube O.D. in.	Ordering Number
1/8	SS-RF-DHL2
1/4	SS-RF-DHL4
3/8	SS-RF-DHL6
1/2	SS-RF-DHL8
9/16	SS-RF-DHL9
3/4	SS-RF-DHL12

Plugs

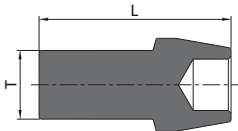

Tube		
T - Tube O.D. in.	Ordering Number	Dimensions, in. (mm)
		L
1/8	SS-TP-DHL2	0.95 (24.2)
1/4	SS-TP-DHL4	1.20 (30.4)
3/8	SS-TP-DHL6	1.19 (30.2)
1/2	SS-TP-DHL8	1.36 (34.6)
9/16	SS-TP-DHL9	1.73 (44.0)
3/4	SS-TP-DHL12	2.30 (58.3)

Caps

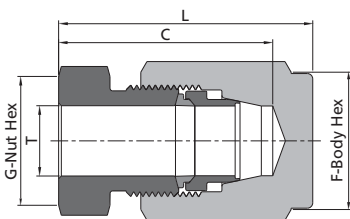

Tube					
T - Tube O.D. in.	Ordering Number	Dimensions, in. (mm)			
		L	C	F	G
1/8	SS-TC-DHL2	1.22 (31.1)	1.07 (27.2)	0.50 (12.7)	0.37 (9.5)
1/4	SS-TC-DHL4	1.70 (43.1)	1.38 (35.2)	0.63 (15.9)	0.63 (15.9)
3/8	SS-TC-DHL6	1.76 (44.8)	1.42 (36.1)	0.75 (19.1)	0.75 (19.1)
1/2	SS-TC-DHL8	2.03 (51.6)	1.56 (39.6)	1.00 (25.4)	0.94 (23.8)
9/16	SS-TC-DHL9	2.47 (62.8)	1.93 (49.0)	1.13 (28.6)	1.06 (27.0)
3/4	SS-TC-DHL12	3.22 (81.9)	2.49 (63.3)	1.50 (38.1)	1.38 (34.9)

Unions

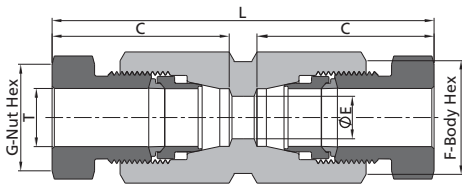

Tube		Dimensions, in. (mm)				
T - Tube O.D. in.	Ordering Number	L	C	E	F	G
1/8	SS-U-DHL2	2.45 (62.2)	1.07 (27.2)	0.09 (2.4)	0.50 (12.7)	0.37 (9.5)
1/4	SS-U-DHL4	3.00 (76.2)	1.38 (35.2)	0.19 (4.8)	0.63 (15.9)	0.63 (15.9)
3/8	SS-U-DHL6	3.07 (77.9)	1.42 (36.1)	0.25 (6.4)	0.75 (19.1)	0.75 (19.1)
1/2	SS-U-DHL8	3.36 (85.4)	1.56 (39.6)	0.37 (9.5)	1.00 (25.4)	0.94 (23.8)
9/16	SS-U-DHL9	4.11 (104.4)	1.93 (49.0)	0.41 (10.4)	1.13 (28.6)	1.06 (27.0)
3/4	SS-U-DHL12	5.38 (136.7)	2.49 (63.3)	0.56 (14.2)	1.50 (38.1)	1.38 (34.9)

Reducing Unions

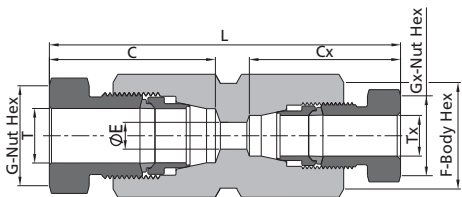

Tube			Dimensions, in. (mm)						
T - Tube O.D. in.	Tx - Tube O.D. in.	Ordering Number	L	C	Cx	E	F	G	Gx
1/4	1/8	SS-U-DHL4-DHL2	2.73 (69.4)	1.39 (35.2)	1.07 (27.2)	0.09 (2.4)	0.63 (15.9)	0.63 (15.9)	0.37 (9.5)
3/8	1/8	SS-U-DHL6-DHL2	2.77 (70.3)	1.42 (36.1)	1.07 (27.2)	0.09 (2.4)	0.75 (19.1)	0.75 (19.1)	0.37 (9.5)
3/8	1/4	SS-U-DHL6-DHL4	3.06 (77.6)	1.42 (36.1)	1.39 (35.2)	0.19 (4.8)	0.75 (19.1)	0.75 (19.1)	0.63 (15.9)
1/2	1/4	SS-U-DHL8-DHL4	3.35 (85.1)	1.56 (39.6)	1.39 (35.2)	0.19 (4.8)	1.00 (25.4)	0.94 (23.8)	0.63 (15.9)
1/2	3/8	SS-U-DHL8-DHL6	3.32 (84.3)	1.56 (39.6)	1.42 (36.1)	0.25 (6.4)	1.00 (25.4)	0.94 (23.8)	0.75 (19.1)
9/16	1/2	SS-U-DHL9-DHL8	4.04 (102.5)	1.93 (49.0)	1.56 (39.6)	0.37 (9.5)	1.13 (28.6)	1.06 (27.0)	0.94 (23.8)
3/4	1/2	SS-U-DHL12-DHL8	4.73 (120.2)	2.49 (63.3)	1.56 (39.6)	0.37 (9.5)	1.50 (38.1)	1.38 (34.9)	0.94 (23.8)

Bulkhead Unions

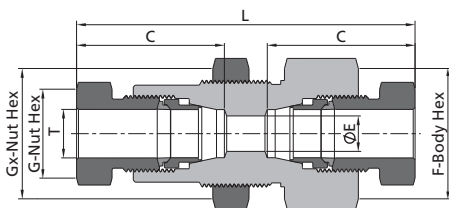

Tube		Dimensions, in. (mm)							
T - Tube O.D. in.	Ordering Number	L	C	E	F	G	Gx	Panel Hole Size	Maximum Panel Thickness
1/8	SS-BU-DHL2	2.95 (75.0)	1.07 (27.2)	0.09 (2.4)	0.75 (19.1)	0.37 (9.5)	0.81 (20.6)	0.69 (17.5)	0.38 (9.7)
1/4	SS-BU-DHL4	3.27 (83.1)	1.38 (35.2)	0.19 (4.8)	1.00 (25.4)	0.63 (15.9)	1.00 (25.4)	0.94 (23.9)	0.38 (9.7)
3/8	SS-BU-DHL6	3.21 (81.6)	1.42 (36.1)	0.25 (6.4)	1.00 (25.4)	0.75 (19.1)	1.06 (27.0)	0.94 (23.9)	0.38 (9.7)
1/2	SS-BU-DHL8	3.93 (99.8)	1.56 (39.6)	0.37 (9.5)	1.38 (34.9)	0.94 (23.8)	1.38 (34.9)	1.13 (28.6)	0.38 (9.7)
9/16	SS-BU-DHL9	4.64 (117.8)	1.93 (49.0)	0.41 (10.4)	1.63 (41.3)	1.06 (27.0)	1.63 (41.3)	1.33 (33.7)	0.38 (9.7)
3/4	SS-BU-DHL12	5.82 (147.9)	2.49 (63.3)	0.56 (14.2)	1.87 (47.6)	1.38 (34.9)	1.87 (47.6)	1.64 (41.7)	0.38 (9.7)

4 DHL Series Tube Fittings and Tubing

Male Connectors

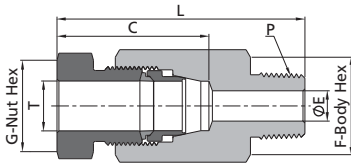

Tube			NPT Thread				
T - Tube O.D. in.	P - NPT Size in.	Ordering Number	Dimensions, in. (mm)				
			L	C	E	F	G
1/8	1/8	SS-CM-DHL2-NS2	1.60 (40.6)	1.07 (27.2)	0.09 (2.4)	0.50 (12.7)	0.37 (9.5)
1/8	1/4	SS-CM-DHL2-NS4	1.72 (43.8)	1.07 (27.2)	0.09 (2.4)	0.56 (14.3)	0.37 (9.5)
1/8	3/8	SS-CM-DHL2-NS6	1.72 (43.8)	1.07 (27.2)	0.09 (2.4)	0.69 (17.5)	0.37 (9.5)
1/4	1/8	SS-CM-DHL4-NS2	1.95 (49.5)	1.39 (35.2)	0.19 (4.8)	0.63 (15.9)	0.63 (15.9)
1/4	1/4	SS-CM-DHL4-NS4	2.08 (52.8)	1.39 (35.2)	0.19 (4.8)	0.63 (15.9)	0.63 (15.9)
1/4	3/8	SS-CM-DHL4-NS6	2.08 (52.8)	1.39 (35.2)	0.19 (4.8)	0.69 (17.5)	0.63 (15.9)
1/4	1/2	SS-CM-DHL4-NS8	2.32 (59.0)	1.39 (35.2)	0.19 (4.8)	0.87 (22.2)	0.63 (15.9)
3/8	1/4	SS-CM-DHL6-NS4	2.17 (55.1)	1.42 (36.1)	0.25 (6.4)	0.75 (19.1)	0.75 (19.1)
3/8	3/8	SS-CM-DHL6-NS6	2.17 (55.1)	1.42 (36.1)	0.25 (6.4)	0.75 (19.1)	0.75 (19.1)
3/8	1/2	SS-CM-DHL6-NS8	2.30 (58.3)	1.42 (36.1)	0.25 (6.4)	0.87 (22.2)	0.75 (19.1)
1/2	1/4	SS-CM-DHL8-NS4	2.53 (64.3)	1.56 (39.6)	0.25 (6.4)	1.00 (25.4)	0.94 (23.8)
1/2	3/8	SS-CM-DHL8-NS6	2.53 (64.3)	1.56 (39.6)	0.31 (7.9)	1.00 (25.4)	0.94 (23.8)
1/2	1/2	SS-CM-DHL8-NS8	2.65 (67.4)	1.56 (39.6)	0.37 (9.5)	1.00 (25.4)	0.94 (23.8)
1/2	3/4	SS-CM-DHL8-NS12	2.53 (64.3)	1.56 (39.6)	0.37 (9.5)	1.06 (27.0)	0.94 (23.8)
9/16	1/4	SS-CM-DHL9-NS4	3.03 (77.0)	1.93 (49.0)	0.25 (6.4)	1.13 (28.6)	1.06 (27.0)
9/16	1/2	SS-CM-DHL9-NS8	3.11 (79.1)	1.93 (49.0)	0.41 (10.4)	1.13 (28.6)	1.06 (27.0)
3/4	1/2	SS-CM-DHL12-NS8	3.74 (95.1)	2.49 (63.3)	0.41 (10.4)	1.50 (38.1)	1.38 (34.9)
3/4	3/4	SS-CM-DHL12-NS12	3.74 (95.1)	2.49 (63.3)	0.56 (14.2)	1.50 (38.1)	1.38 (34.9)
3/4	1	SS-CM-DHL12-NS16	3.83 (97.4)	2.49 (63.3)	0.56 (14.2)	1.50 (38.1)	1.38 (34.9)

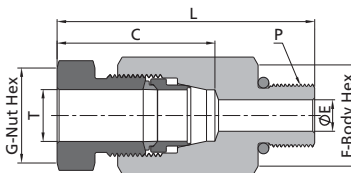

Tube			Heavy-duty SAE/MS				
T - Tube O.D. in.	P - SAE/MS Thread Size	Ordering Number	Dimensions, in. (mm)				
			L	C	E	F	G
1/8	7/16-20	SS-CM-DHL2-SH7	1.60 (40.6)	1.07 (27.2)	0.09 (2.4)	0.56 (14.3)	0.37 (9.5)
1/8	9/16-18	SS-CM-DHL2-SH9	1.66 (42.2)	1.07 (27.2)	0.09 (2.4)	0.69 (17.5)	0.37 (9.5)
1/4	7/16-20	SS-CM-DHL4-SH7	2.04 (51.7)	1.39 (35.2)	0.18 (4.5)	0.63 (15.9)	0.63 (15.9)
1/4	9/16-18	SS-CM-DHL4-SH9	2.07 (52.7)	1.39 (35.2)	0.19 (4.8)	0.69 (17.5)	0.63 (15.9)
3/8	7/16-20	SS-CM-DHL6-SH7	2.09 (53.0)	1.42 (36.1)	0.18 (4.5)	0.75 (19.1)	0.75 (19.1)
3/8	9/16-18	SS-CM-DHL6-SH9	2.13 (54.0)	1.42 (36.1)	0.25 (6.4)	0.75 (19.1)	0.75 (19.1)
1/2	7/16-20	SS-CM-DHL8-SH7	2.49 (63.3)	1.56 (39.6)	0.18 (4.5)	1.00 (25.4)	0.94 (23.8)
1/2	9/16-18	SS-CM-DHL8-SH9	2.49 (63.3)	1.56 (39.6)	0.30 (7.5)	1.00 (25.4)	0.94 (23.8)

Female Connectors

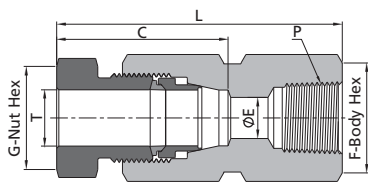

Tube			NPT Thread				
T - Tube O.D. in.	P - NPT Size in.	Ordering Number	Dimensions, in. (mm)				
			L	C	E	F	G
1/8	1/8	SS-CF-DHL2-NS2	1.97 (50.1)	1.07 (27.2)		0.63 (15.9)	0.37 (9.5)
1/8	1/4	SS-CF-DHL2-NS4	2.01 (53.3)	1.07 (27.2)		0.94 (23.8)	0.37 (9.5)
1/4	1/4	SS-CF-DHL4-NS4	2.33 (59.1)	1.38 (35.2)		0.94 (23.8)	0.63 (15.9)
3/8	1/4	SS-CF-DHL6-NS4	2.42 (61.5)	1.42 (36.1)		0.94 (23.8)	0.75 (19.1)
1/2	1/4	SS-CF-DHL8-NS4	2.78 (70.6)	1.56 (39.6)		1.00 (25.4)	0.94 (23.8)
1/2	1/2	SS-CF-DHL8-NS8	3.03 (77.0)	1.56 (39.6)		1.38 (34.9)	0.94 (23.8)
3/4	1/2	SS-CF-DHL12-NS8	3.85 (97.8)	2.49 (63.3)		1.50 (38.1)	1.38 (34.9)

Union Elbows

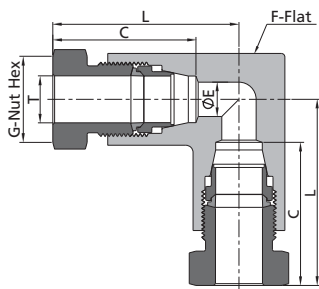

Tube		Dimensions, in. (mm)				
T - Tube O.D. in.	Ordering Number	L	C	E	F	G
1/8	SS-LU-DHL2	1.29 (32.7)	1.07 (27.2)	0.09 (2.4)	0.63 (15.9)	0.37 (9.5)
1/4	SS-LU-DHL4	1.70 (43.1)	1.38 (35.2)	0.19 (4.8)	0.63 (15.9)	0.63 (15.9)
3/8	SS-LU-DHL6	1.67 (42.4)	1.42 (36.1)	0.25 (6.4)	0.75 (19.1)	0.75 (19.1)
1/2	SS-LU-DHL8	2.03 (51.6)	1.56 (39.6)	0.37 (9.5)	1.00 (25.4)	0.94 (23.8)
9/16	SS-LU-DHL9	2.43 (61.8)	1.93 (49.0)	0.41 (10.4)	1.38 (34.9)	1.06 (27.0)
3/4	SS-LU-DHL12	3.11 (79.1)	2.49 (63.3)	0.56 (14.2)	1.50 (38.1)	1.38 (34.9)

Union Reducing Elbows

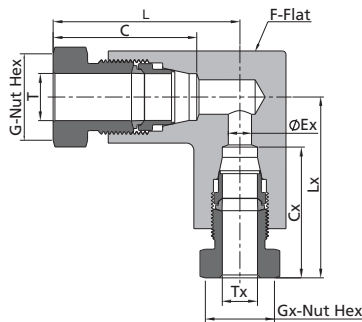

Tube			Dimensions, in. (mm)							
T - Tube O.D. in.	Tx - Tube O.D. in.	Ordering Number	L	Lx	C	Cx	Ex	F	G	Gx
1/4	1/8	SS-LU-DHL4-DHL2	1.70 (43.1)	1.37 (34.7)	1.38 (35.2)	1.07 (27.2)	0.09 (2.4)	0.63 (15.9)	0.63 (15.9)	0.37 (9.5)
3/8	1/8	SS-LU-DHL6-DHL2	1.67 (42.4)	1.33 (33.7)	1.42 (36.1)	1.07 (27.2)	0.09 (2.4)	0.75 (19.1)	0.75 (19.1)	0.37 (9.5)
3/8	1/4	SS-LU-DHL6-DHL4	1.67 (42.4)	1.70 (43.1)	1.42 (36.1)	1.38 (35.2)	0.19 (4.8)	0.75 (19.1)	0.75 (19.1)	0.63 (15.9)
1/2	1/4	SS-LU-DHL8-DHL4	2.03 (51.6)	1.95 (49.5)	1.56 (39.6)	1.38 (35.2)	0.19 (4.8)	0.94 (23.8)	0.94 (23.8)	0.63 (15.9)
1/2	3/8	SS-LU-DHL8-DHL6	2.03 (51.6)	1.96 (49.8)	1.56 (39.6)	1.42 (36.1)	0.25 (6.4)	0.94 (23.8)	0.94 (23.8)	0.75 (19.1)
9/16	1/2	SS-LU-DHL9-DHL8	2.43 (61.8)	2.37 (40.3)	1.93 (49.0)	1.56 (39.6)	0.37 (9.5)	1.38 (34.9)	1.06 (27.0)	0.94 (23.8)
3/4	1/2	SS-LU-DHL12-DHL8	3.11 (79.1)	2.81 (71.3)	2.49 (63.3)	1.56 (39.6)	0.37 (9.5)	1.50 (38.1)	1.38 (34.9)	0.94 (23.8)

6 DHL Series Tube Fittings and Tubing

Male Elbows

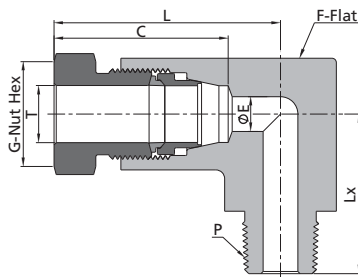

Tube			NPT Thread						
T - Tube O.D. in.	P - NPT Size in.	Ordering Number	Dimensions, in. (mm)						
			L	Lx	C	E	F	G	
1/8	1/8	SS-LM-DHL2-NS2	1.29 (32.7)	0.79 (20.0)	1.07 (27.2)	0.09 (2.4)	0.63 (15.9)	0.37 (9.5)	
1/8	1/4	SS-LM-DHL2-NS4	1.39 (35.3)	1.00 (25.4)	1.07 (27.2)	0.09 (2.4)	0.63 (15.9)	0.37 (9.5)	
1/8	3/8	SS-LM-DHL2-NS6	1.47 (37.4)	1.00 (25.4)	1.07 (27.2)	0.09 (2.4)	0.75 (19.1)	0.37 (9.5)	
1/4	1/4	SS-LM-DHL4-NS4	1.70 (43.1)	0.94 (23.8)	1.38 (35.2)	0.19 (4.8)	0.63 (15.9)	0.63 (15.9)	
1/4	3/8	SS-LM-DHL4-NS6	1.70 (43.1)	1.00 (25.4)	1.38 (35.2)	0.19 (4.8)	0.75 (19.1)	0.63 (15.9)	
1/4	1/2	SS-LM-DHL4-NS8	1.70 (43.1)	1.38 (34.9)	1.38 (35.2)	0.19 (4.8)	1.00 (25.4)	0.63 (15.9)	
3/8	1/4	SS-LM-DHL6-NS4	1.67 (42.4)	1.00 (25.4)	1.42 (36.1)	0.25 (6.4)	0.75 (19.1)	0.75 (19.1)	
3/8	3/8	SS-LM-DHL6-NS6	1.67 (42.4)	1.06 (27.0)	1.42 (36.1)	0.25 (6.4)	0.75 (19.1)	0.75 (19.1)	
3/8	1/2	SS-LM-DHL6-NS8	1.67 (42.4)	1.38 (34.9)	1.42 (36.1)	0.25 (6.4)	1.00 (25.4)	0.75 (19.1)	
1/2	1/4	SS-LM-DHL8-NS4	2.03 (51.6)	1.19 (30.2)	1.56 (39.6)	0.25 (6.4)	1.00 (25.4)	0.94 (23.8)	
1/2	3/8	SS-LM-DHL8-NS6	2.03 (51.6)	1.19 (30.2)	1.56 (39.6)	0.31 (7.9)	1.00 (25.4)	0.94 (23.8)	
1/2	1/2	SS-LM-DHL8-NS8	2.03 (51.6)	1.38 (34.9)	1.56 (39.6)	0.37 (9.5)	1.00 (25.4)	0.94 (23.8)	
9/16	1/2	SS-LM-DHL9-NS8	2.43 (61.8)	1.56 (39.5)	1.93 (49.0)	0.41 (10.4)	1.38 (34.9)	1.06 (27.0)	
3/4	1/2	SS-LM-DHL12-NS8	3.11 (79.1)	1.73 (44.0)	2.49 (63.3)	0.41 (10.4)	1.50 (38.1)	1.38 (34.9)	
3/4	3/4	SS-LM-DHL12-NS12	3.11 (79.1)	1.73 (44.0)	2.49 (63.3)	0.56 (14.2)	1.50 (38.1)	1.38 (34.9)	

Union Tees

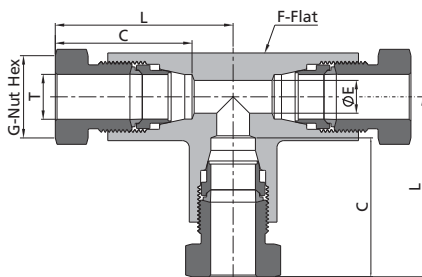

Tube		Dimensions, in. (mm)				
T - Tube O.D. in.	Ordering Number	L	C	E	F	G
1/8	SS-TTT-DHL2	1.37 (34.7)	1.07 (27.2)	0.09 (2.4)	0.63 (15.9)	0.37 (9.5)
1/4	SS-TTT-DHL4	1.70 (43.1)	1.38 (35.2)	0.19 (4.8)	0.63 (15.9)	0.63 (15.9)
3/8	SS-TTT-DHL6	1.67 (42.4)	1.42 (36.1)	0.25 (6.4)	0.75 (19.1)	0.75 (19.1)
1/2	SS-TTT-DHL8	2.03 (51.6)	1.56 (39.6)	0.37 (9.5)	1.00 (25.4)	0.94 (23.8)
9/16	SS-TTT-DHL9	2.43 (61.8)	1.93 (49.0)	0.41 (10.4)	1.38 (34.9)	1.06 (27.0)
3/4	SS-TTT-DHL12	3.11 (79.1)	2.49 (63.3)	0.56 (14.2)	1.50 (38.1)	1.38 (34.9)

Male Branch Tees

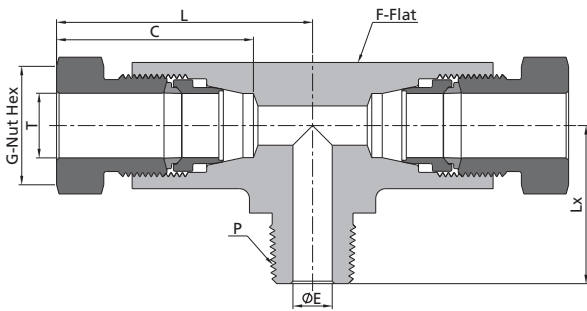

Tube			NPT Thread						
T - Tube O.D. in.	P - NPT Size in.	Ordering Number	Dimensions, in. (mm)						
			L	Lx	C	E	F	G	
1/8	1/8	SS-TTM-DHL2-NS2	1.37 (34.7)	0.79 (20.0)	1.07 (27.2)	0.09 (2.4)	0.63 (15.9)	0.37 (9.5)	
1/8	1/4	SS-TTM-DHL2-NS4	1.37 (34.7)	1.00 (25.4)	1.07 (27.2)	0.09 (2.4)	0.63 (15.9)	0.37 (9.5)	
1/4	1/8	SS-TTM-DHL4-NS2	1.70 (43.1)	0.81 (20.6)	1.38 (35.2)	0.19 (4.8)	0.63 (15.9)	0.63 (15.9)	
1/4	1/4	SS-TTM-DHL4-NS4	1.70 (43.1)	1.00 (25.4)	1.38 (35.2)	0.19 (4.8)	0.63 (15.9)	0.63 (15.9)	
3/8	1/4	SS-TTM-DHL6-NS4	1.67 (42.4)	1.06 (27.0)	1.42 (36.1)	0.25 (6.4)	0.75 (19.1)	0.75 (19.1)	
1/2	1/4	SS-TTM-DHL8-NS4	2.03 (51.6)	1.19 (30.2)	1.56 (39.6)	0.25 (6.4)	1.00 (25.4)	0.94 (23.8)	
1/2	3/8	SS-TTM-DHL8-NS6	2.03 (51.6)	1.19 (30.2)	1.56 (39.6)	0.31 (7.9)	1.00 (25.4)	0.94 (23.8)	
3/4	3/4	SS-TTM-DHL12-NS12	3.11 (79.1)	1.73 (44.0)	2.49 (63.3)	0.56 (14.2)	1.50 (38.1)	1.38 (34.9)	

Union Crosses

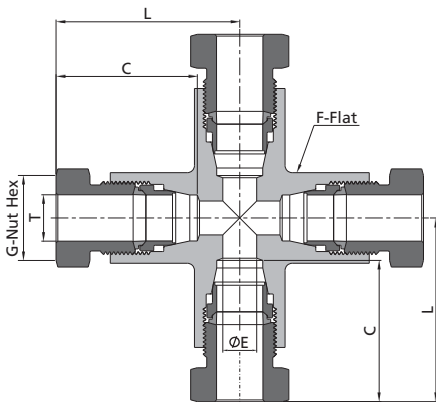

Tube		Dimensions, in. (mm)				
T - Tube O.D. in.	Ordering Number	L	C	E	F	G
1/8	SS-C-DHL2	1.37 (34.7)	1.07 (27.2)	0.09 (2.4)	0.63 (15.9)	0.37 (9.5)
1/4	SS-C-DHL4	1.70 (43.1)	1.38 (35.2)	0.19 (4.8)	0.63 (15.9)	0.63 (15.9)
3/8	SS-C-DHL6	1.67 (42.4)	1.42 (36.1)	0.25 (6.4)	0.75 (19.1)	0.75 (19.1)
1/2	SS-C-DHL8	2.03 (51.6)	1.56 (39.6)	0.37 (9.5)	1.00 (25.4)	0.94 (23.8)
9/16	SS-C-DHL9	2.43 (61.8)	1.93 (49.0)	0.41 (10.4)	1.38 (34.9)	1.06 (27.0)
3/4	SS-C-DHL12	3.11 (79.1)	2.49 (63.3)	0.56 (14.2)	1.50 (38.1)	1.38 (34.9)

8 DHL Series Tube Fittings and Tubing

Reducers^①

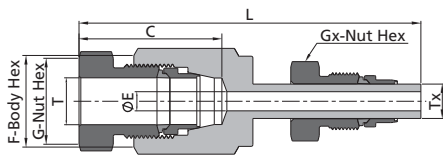

Tube			Dimensions, in. (mm)						
T - Tube O.D. in.	Tx - Tube O.D. in.	Ordering Number	L	C	E	F	G	Gx	
1/4	3/8	SS-R-DHL4-DHM6	3.20 (82.1)	1.38 (35.2)	0.19 (4.8)	0.63 (15.9)	0.63 (15.9)	0.75 (19.1)	
1/4	1/2	SS-R-DHL4-DHM8	3.37 (85.5)	1.38 (35.2)	0.19 (4.8)	0.63 (15.9)	0.63 (15.9)	0.94 (23.8)	
3/8	1/2	SS-R-DHL6-DHM8	3.43 (87.1)	1.42 (36.1)	0.25 (6.4)	0.75 (19.1)	0.75 (19.1)	0.94 (23.8)	
1/2	3/8	SS-R-DHL8-DHM6	3.53 (89.7)	1.56 (39.6)	0.21 (5.3)	1.00 (25.4)	0.94 (23.8)	0.75 (19.1)	
1/2	3/4	SS-R-DHL8-DHM12	5.13 (130.4)	1.56 (39.6)	0.37 (9.5)	1.00 (25.4)	0.94 (23.8)	1.38 (34.9)	
9/16	3/4	SS-R-DHL9-DHM12	5.32 (135.1)	1.93 (49.0)	0.41 (10.4)	1.13 (28.6)	1.06 (27.0)	1.38 (34.9)	
3/4	9/16	SS-R-DHL12-DHM9	5.46 (138.6)	2.49 (63.3)	0.31 (7.9)	1.50 (38.1)	1.38 (34.9)	1.06 (27.0)	

① The right ends of reducers will have been preassembled with ferrules before shipping. Please follow the Reinstallation Instructions when installing the reducers.

Port Connectors^①

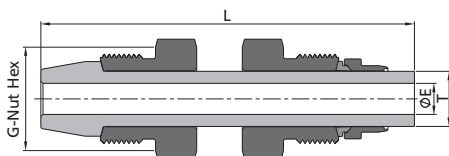

Tube			Dimensions, in. (mm)		
T - Tube O.D. in.	Ordering Number	L	E	G	
1/8	SS-P-DHL2	1.94 (49.2)	0.06 (1.6)	0.37 (9.5)	
1/4	SS-P-DHL4	2.49 (63.2)	0.12 (3.0)	0.63 (15.9)	
3/8	SS-P-DHL6	2.58 (65.5)	0.21 (5.3)	0.75 (19.1)	
1/2	SS-P-DHL8	2.85 (72.3)	0.28 (7.1)	0.94 (23.8)	
9/16	SS-P-DHL9	3.60 (91.4)	0.31 (7.9)	1.06 (27.0)	
3/4	SS-P-DHL12	4.52 (114.9)	0.42 (10.7)	1.38 (34.9)	

① The port connectors will have been preassembled with ferrules before shipping. Please follow the Reinstallation Instructions when installing the port connectors.

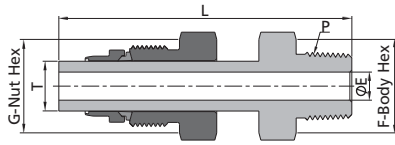
Adapters^①

Tube			NPT Thread			
T - Tube O.D. in.	P - NPT Size	Ordering Number	Dimensions, in. (mm)			
			L	E	F	G
1/4	1/4	SS-AM-DHM4-NS4	2.30 (58.5)	0.12 (3.0)	0.56 (14.3)	0.63 (15.9)
3/8	1/4	SS-AM-DHM6-NS4	2.38 (60.4)	0.21 (5.3)	0.56 (14.3)	0.75 (19.1)
3/8	1/2	SS-AM-DHM6-NS8	2.67 (67.9)	0.21 (5.3)	0.87 (22.2)	0.75 (19.1)
1/2	1/4	SS-AM-DHM8-NS4	2.55 (64.8)	0.25 (6.4)	0.56 (14.3)	0.94 (23.8)
1/2	1/2	SS-AM-DHM8-NS8	2.84 (72.2)	0.28 (7.1)	0.87 (22.2)	0.94 (23.8)
9/16	1/2	SS-AM-DHM9-NS8	3.64 (92.4)	0.31 (7.9)	0.87 (22.2)	1.06 (27.0)
3/4	3/4	SS-AM-DHM12-NS12	4.22 (107.1)	0.39 (10.0)	1.06 (27.0)	1.38 (34.9)

① The port connectors will have been preassembled with ferrules before shipping. Please follow the Reinstallation Instructions when installing the adapters.

NOTE: Dimensions are for reference only and are subject to change.

Ordering Number Description

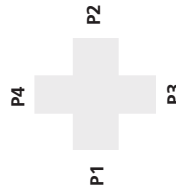
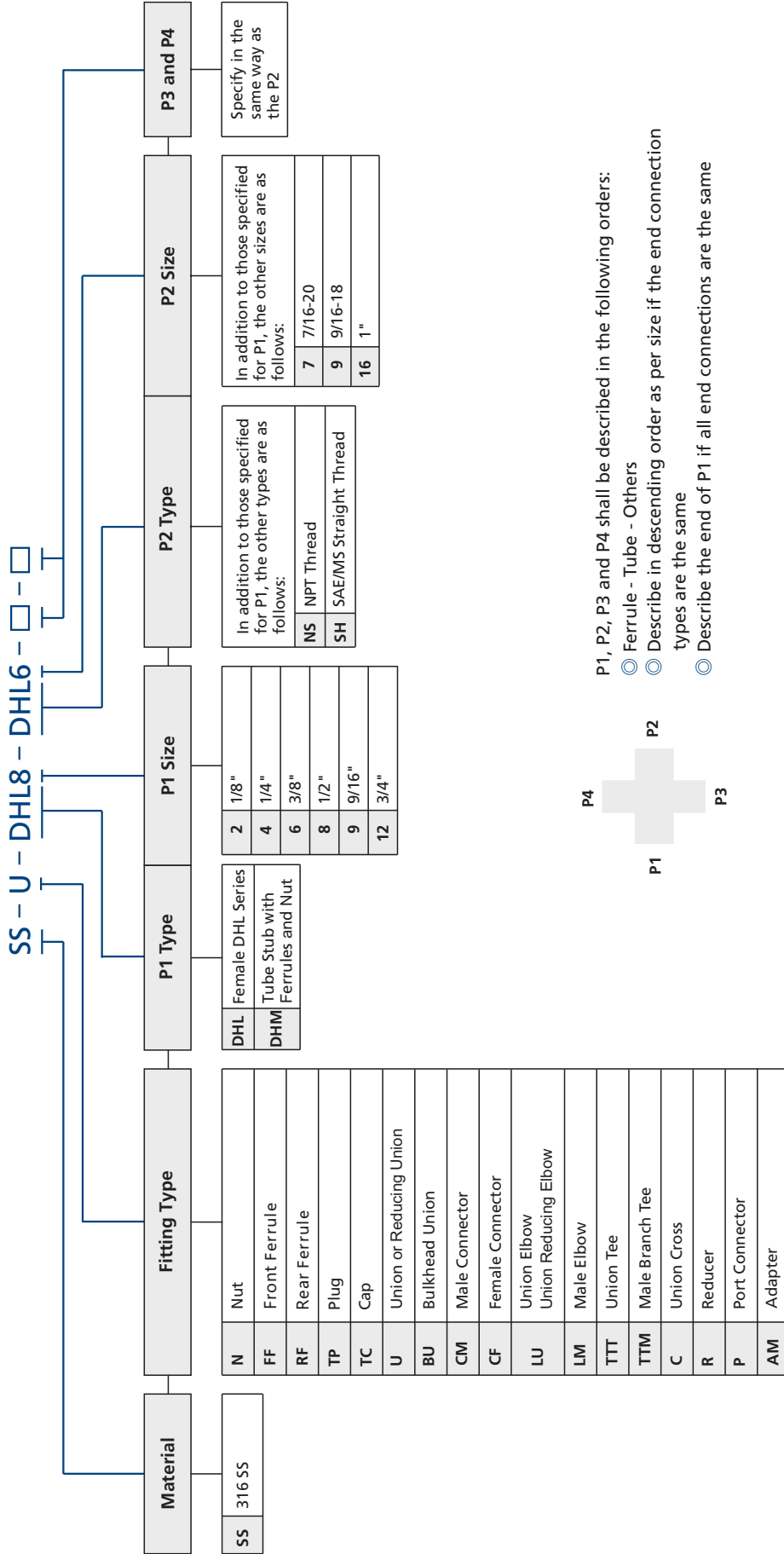

- P1, P2, P3 and P4 shall be described in the following orders:
- ⊙ Ferrule - Tube - Others
 - ⊙ Describe in descending order as per size if the end connection types are the same
 - ⊙ Describe the end of P1 if all end connections are the same

NOTE: "Ordering Number Description" is a reference to understand the combination rules of FITOK product part number. Not all combinations are available.

Tubing

Features

- ⦿ Working pressure up to 15,000 psig (1034 bar)
- ⦿ Working temperature range: -325°F to 800°F (-198°C to 427°C)
- ⦿ Material, size, pressure and heat number marked on the tubing surface
- ⦿ Seamless, cold-drawn and work-hardened to achieve high strength and corrosion resistance
- ⦿ Use with DHL Series tube fittings



Material Standards and Mechanical Properties

Cold-drawn 1/8-Hard Stainless Steel Seamless Tubing

Material Grade	UNS	Yield Strength ksi	Tensile Strength ksi	Elongation in 2 in. min.%	Hardness, Max.
316/316L	S31600/S31603	75 to 110	105 to 140	20	26 HRC

Heavy-wall Annealed Stainless Steel Seamless Tubing^①

Material Grade	UNS	Yield Strength, min, ksi	Tensile Strength, min, ksi	Elongation in 2 in. min.%	Hardness, Max.
316/316L	S31600/S31603	30	75	35	90 HRB

① Fully annealed, high-quality type 316/316L stainless steel tubing ASTM A269 or A213, or equivalent.

Working Pressure

- ⦿ The allowable working pressures in the table below are based on ASME B31.3 at ambient temperature.
- ⦿ To get the allowable working pressure at elevated temperature, use the allowable working pressure at ambient temperature to multiply the factors in the table of Elevated Temperature Factors on the next page.

Cold-drawn 1/8-Hard Stainless Steel Seamless Tubing

Tube O.D. in.	Wall Thickness in.	Working Pressure psig (bar)
1/4	0.065	15,000 (1034)
3/8	0.083	15,000 (1034)
1/2	0.109	15,000 (1034)
9/16	0.125	15,000 (1034)
3/4	0.165	15,000 (1034)

Heavy-wall Annealed Stainless Steel Seamless Tubing

Tube O.D. in.	Wall Thickness in.	Working Pressure psig (bar)
1/8	0.037	15,000 (1034)
1/4	0.083	15,000 (1034)
1/4	0.065	10,300 (710)
3/8	0.118	15,000 (1034)
3/8	0.095	10,000 (690)
1/2	0.156	15,000 (1034)
1/2	0.134	11,200 (772)
9/16	0.188	15,000 (1034)
3/4	0.240	15,000 (1034)
3/4	0.188	10,000 (690)

12 DHL Series Tube Fittings and Tubing

Elevated Temperature Factors

Material Grade	Temperature		Factor
	°F	°C	
316/316L	100	38	1.00
	200	93	1.00
	300	149	1.00
	400	204	0.96
	500	260	0.89
	600	316	0.85
	700	371	0.81
	800	427	0.79

Ordering Information

Cold-drawn 1/8-Hard Stainless Steel Seamless Tubing

Tube O.D. in.	Wall Thickness in.	Basic Ordering Number	Tolerance O.D. in.	Wall Thickness Tolerance in.
1/4	0.065	SS-15T4H-065-	0.255/0.245	0.0585/0.0715
3/8	0.083	SS-15T6H-083-	0.370/0.380	0.0747/0.0913
1/2	0.109	SS-15T8H-109-	0.505/0.495	0.9810/0.1199
9/16	0.125	SS-15T9H-125-	0.557/0.567	0.1125/0.1375
3/4	0.165	SS-15T12H-165-	0.745/0.755	0.1485/0.1815

Heavy-wall Annealed Stainless Steel Seamless Tubing

Tube O.D. in.	Wall Thickness in.	Basic Ordering Number	Tolerance O.D. in.	Wall Thickness Tolerance in.
1/8	0.037	SS-15T2-037-	0.128/0.122	0.0333/0.0407
1/4	0.083	SS-15T4-083-	0.255/0.245	0.0747/0.0913
1/4	0.065	SS-15T4-065-	0.255/0.245	0.0585/0.0715
3/8	0.118	SS-15T6-118-	0.370/0.380	0.1062/0.1298
3/8	0.095	SS-15T6-095-	0.370/0.380	0.0855/0.1045
1/2	0.156	SS-15T8-156-	0.505/0.495	0.1404/0.1716
1/2	0.134	SS-15T8-134-	0.505/0.495	0.1206/0.1474
9/16	0.188	SS-15T9-188-	0.557/0.567	0.1692/0.2068
3/4	0.240	SS-15T12-240-	0.745/0.755	0.2160/0.2640
3/4	0.188	SS-15T12-188-	0.745/0.755	0.1692/0.2068

Add the length designator as a suffix to the basic ordering number to get the complete ordering number. The length designator "-10" means 10 feet. The length designator "-3M" means 3 meters.

Examples:

1. If 10 feet of 1/8" O.D. annealed tubing is needed, the complete ordering number is SS-15T2-037-10.
2. If 3 meters of 1/8" O.D. annealed tubing is needed, the complete ordering number is SS-15T2-037-3M.

NOTE: The tubing is available in random lengths but no more than 20 feet (6 meters).

Installation Instructions

For Tube O.D. 1/8", 1/4", 3/8" and 1/2"

Without Manual Presetting Tool

1. Put the nut and ferrules onto the tubing in fixed sequence and orientation (Fig. 1).
2. Insert the tubing into the fitting body or the valve. Finger tight the nut. Make sure that the tubing rests firmly on the shoulder of the fitting body or the valve (Fig. 2).
3. Mark the nut and the fitting body or the valve (Fig. 3).
4. Hold the fitting body or the valve steady. For tube O.D. 1/8", tighten the nut 1 1/4 turns with a wrench. For tube O.D. 1/4", 3/8" and 1/2", tighten the nut 1 1/2 turns with a wrench (Fig. 4).

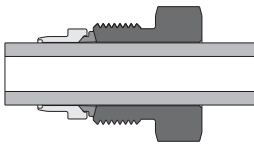

Fig.1

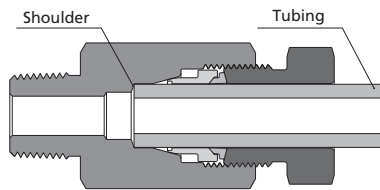

Fig.2

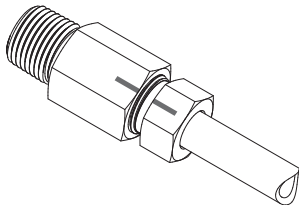

Fig.3

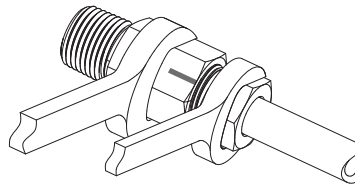

Fig.4

With Manual Presetting Tool

1. Put the nut and ferrules onto the tubing in fixed sequence and orientation (Fig. 1).
2. Insert the tubing into the manual presetting tool. Finger tight the nut. Make sure that the tubing rests firmly on the shoulder of the presetting tool (Fig. 5).
3. Mark the nut and the manual presetting tool (Fig. 6).
4. Hold the manual presetting tool steady. For tube O.D. 1/8", tighten the nut 1 1/4 turns with a wrench. For tube O.D. 1/4", 3/8" and 1/2", tighten the nut 1 1/2 turns with a wrench.
5. Loosen the nut and remove the tubing with preassembled ferrules from the manual presetting tool (Fig. 7).

NOTE: If the tubing sticks into the manual presetting tool, remove the tubing by gently rocking it back and forth. Do not rotate the tubing.

6. Insert the tubing with preassembled ferrules into the fitting body or the valve. Finger tight the nut (Fig. 8).
7. Tighten the nut 1/4 turn with a wrench while holding the fitting body or the valve steady.

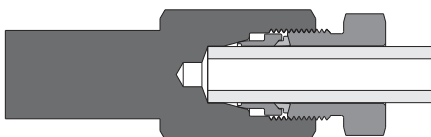

Fig.5

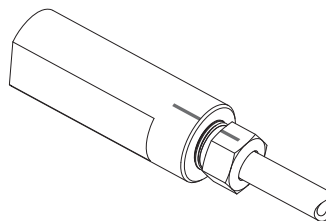

Fig.6

14 DHL Series Tube Fittings and Tubing

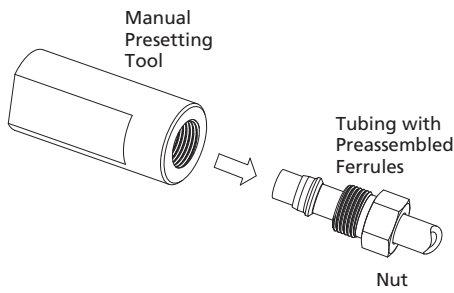

Fig.7

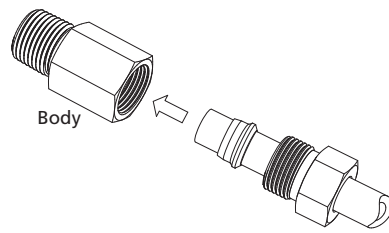

Fig.8

For Tube O.D. 9/16", 3/4" and 1/2"

1. Preassemble the ferrules onto tubing using the hydraulic presetting tool. For details, please contact FITOK for instruction manual **Hydraulic Presetting Tools**.
2. Insert the tubing with preassembled ferrules into the fitting body or the valve. Finger tight the nut.
3. Tighten the nut 1/4 turn with a wrench while holding the fitting body or the valve steady.

For Plugs

1. Insert the plug into the fitting body or the valve. Finger tight the nut.
2. Tighten the nut 1/4 turn with a wrench while holding the fitting body or the valve steady.

Reinstallation Instructions

1. Insert the tubing with preassembled ferrules into the fitting body or the valve. Finger tight the nut.
2. Tighten the nut 1/4 turn with a wrench while holding the fitting body or the valve steady. After frequent reassemblies, 1/8 turn might be sufficient.

Cautions

1. Do not loosen or tighten fittings when the system is pressurized.
2. When assembling a tube fitting, screw the nut while holding the body steady.

Tools and Accessories

Manual Presetting Tools

To preset double ferrules onto DHL Series tubing. Tubing sizes available in 1/8", 1/4", 3/8" and 1/2" O.D.

Ordering Number	Tube O.D., in.
PST-2D	1/8
PST-4D	1/4
PST-6D	3/8
PST-8D	1/2

Hydraulic Presetting Tools

To preset double ferrules onto DHL Series tubing. Tubing sizes available in 1/2", 9/16" and 3/4" O.D.

Ordering Number	Description
HPT-DHF	With full set of die heads
HPT-H	Without die heads The die heads can be ordered individually.

Die Heads

Ordering Number	Tube O.D., in.
HPT-H-DHL8	1/2
HPT-H-DHL9	9/16
HPT-H-DHL12	3/4



FITOK Group

FITOK GmbH (Headquarter)

Sprendlinger Landstr. 115, 63069 Offenbach am Main, Germany
Tel.: +49 69 8900 4498 Fax: +49 69 8900 4495

FITOK, Inc.

13843 North Promenade Blvd., Suite 750, Stafford, Texas 77477, USA
Tel.: +1 281 888 0077 Fax: +1 281 582 4051

FITOK Incorporated

1-4F, Block C, Zone E, Yingtai Industrial Park, Dalang Street,
Longhua New District, Shenzhen, Guangdong 518109, China
Tel.: +86 755 2803 2500 Fax: +86 755 2803 2619

FITOK Middle East Oil Equipment Trading LLC

208-209, Makateb Building, P.O.Box 185412, Airport Road, Deira, Dubai, UAE
Tel.: +971 4 2959 853 Fax: +971 4 2959 854

info@fitokgroup.com
www.fitokgroup.com

FK-IC-HF-07-EN-170613